

PT.OXA JAYA INDONESIA

**Construction Pedestrian Specialis
Since 2017**

www.oxajayaindonesia.com

Tentang kami :

PT. Oxa Jaya Indonesia berdiri sejak tahun 2017, berkedudukan di Jakarta Utara.

PT.Oxa Jaya Indonesia adalah Perusahaan supplier bahan-bahan untuk Trotoar/Pejalan kaki/Walkway yang sebagai pelengkap aksessories keindahan.

Bahan-bahan yang dibuat dari dalam negeri yang mengandung unsur TKDN diatas yang ditentukan oleh Pemerintah.

Produk yang kami tawarkan adalah :

1. Andesit Batu Alam
2. Granite Batu alam
3. Guiding blok Kuning -Berbahan : komposite, Granite, precast, Alumunium, Stainless Stell.
4. Inlet [mulut air] - Andesit.
5. Bollard - Berbahan : Andesit, Precast Besi.



UNDERPASS SENEN

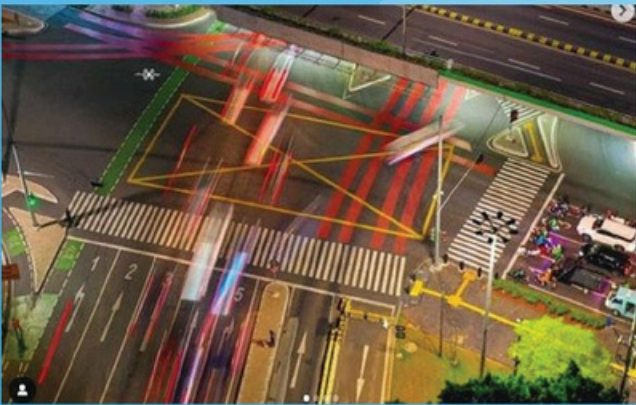

VID Granite Namdinh

Sejak tahun 2021 telah sukse terpasang di Undepass Senen

FEATURED PROJECT



PENGADILAH NEGERI KARANGANYAR

Tayneks Tactile Thermoplastic
Polyurethane
Since February 2021
Launched in Karanganyar



**INDONESIAN
PRESIDENTIAL PALACE**

QUA Granite Pulpis Grey - Glazed Polished.
Since September 2020
has successfully deployed.



KUPANG

QUA Granite Tactile Grey



SARINAH - JAKARTA

VID Granite Namdinh

FEATURED PROJECT



GRANITE TACTILE

Stasiun Kereta Api Gambir
Jakarta Pusat

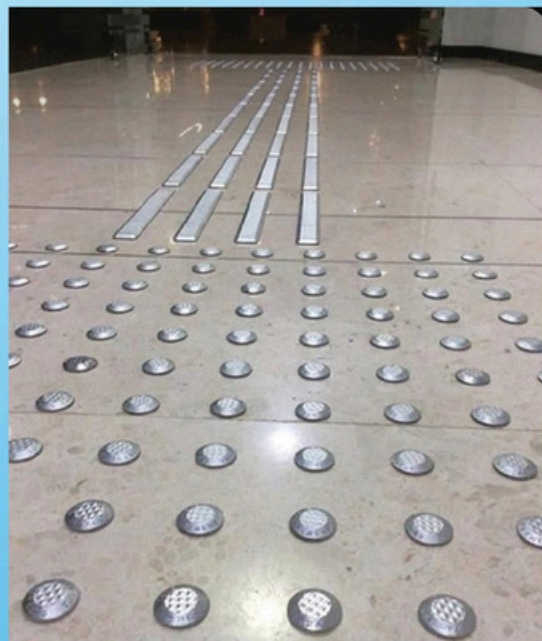

ALUMINIUM TACTILE

Gedung Universitas
Pendidikan Indonesia, Bandung



GRANITE TACTILE

Stasiun Kereta Api Manggarai
Jakarta Selatan



GRANITE TACTILE

Alun - Alun Kota Bogor
Jawa Barat

FEATURED PROJECT



GRANITE TACTILE

Jl Jendral Sudirman
Daerah Istimewa Yogyakarta
Jawa Tengah

GRANITE TACTILE

Alun - Alun Kejaksaan
Kota Cirebon, Jawa Barat





ISTANA NEGARA JAKARTA

QUA Granite Polish

60x120 maiorca grey

since July 2020

has successfully launched.

TERMINAL JOYOBOYO

Porcelain Tile and Granite

all from QUA product.

Since 2019 has successfully

launched in Joyoboyo



OUR PROJECT



TERMINAL JOYOBOYO

Porcelain Tile and Granite all from QUA products.
Since 2019 has successfully launched in Joyoboyo.



ISTANA NEGARA JAKARTA

QUA Granite Polish 60x120 Maiorca Grey.
Since July 2020 has successfully launched.



PENGADILAN NEGERI KARANGANYAR

Tayneks Tactile Thermoplastic Polyurethane.
Since Feb 2021 has successfully launched in Karanganyar.

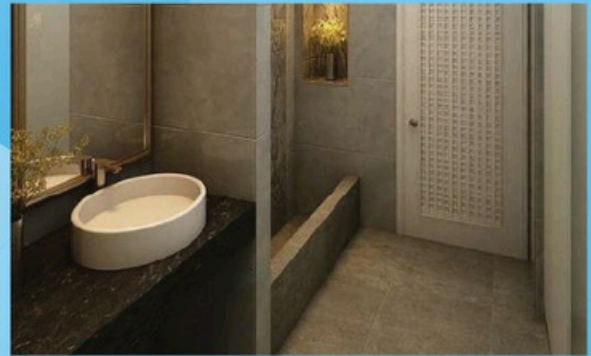

INDONESIAN PRESIDENTIAL PALACE

QUA Granite Pulpis Grey - Glazed Polished.
Since Sept 2020 has successfully deployed.



KUPANG

QUA Granite Tactile Grey



SARINAH

VID Granite Namdinh

OUR PROJECT

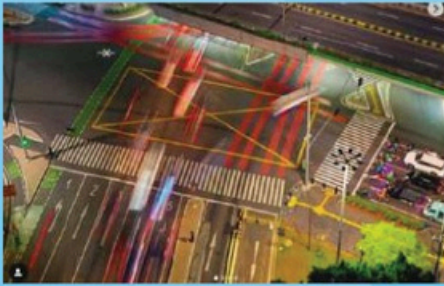

UNDERPASS SENEN

Tactile Granite Guiding Blok Super Yellow
Since 2021 has successfully launched in Senen, Jakarta.

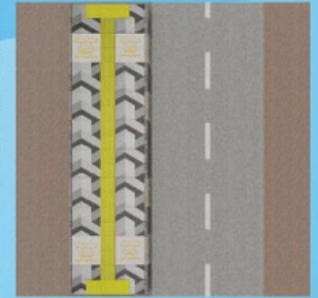

Jl. Wolter Monginsidi
Kota Bandar Lampung, Sumatera Selatan

Jl. Ryacudu, Lampung

Tactile Granite Guiding Blok Super Yellow
Havante Granite Tiles



Pekerjaan Pemasangan di IKN
Sumbu Kebangsaan tahap satu dan dua, Kalimantan Timur

OUR PROJECT



PROJECT DI TANAH ABANG, JAKARTA PUSAT



PROJECT JAKARTA INTERNATIONAL STADIUM, ANCOL. JAKARTA UTARA



PROJECT DI MARGONDA CITY - BOLLARD HITAM

PROJECT JALANAN DI JAKARTA PUSAT

PT OXA JAYA INDONESIA

Jl. Pluit Indah 168 B-G, Jakarta Utara 14450

Mobile. 0812 9301 4188

Email. sales@oxajayaindonesia.com

<http://www.oxajayaindonesia.com>



BROSUR KATALOG

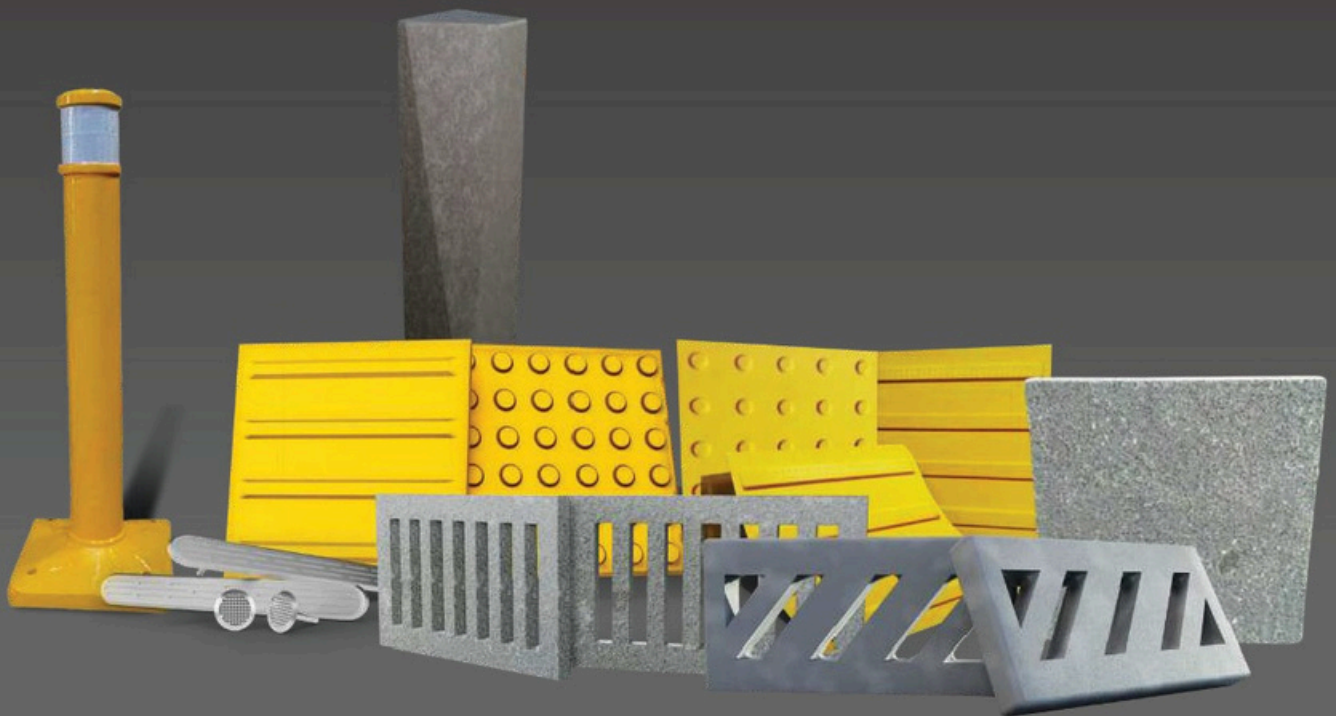

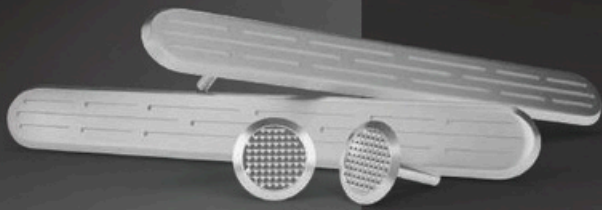

Alumunium Tactile

Indoor dan Outdoor

Aluminium ulet dan memiliki titik leleh dan kerapatan yang rendah. Itu dapat diproses dengan beberapa cara dalam kondisi cair. Daktilitasnya memungkinkan produk aluminium dibentuk mendekati akhir desain produk.

● Applications

Interior dan Eksterior
Alun-alun
Airport
Bus Stop / Halte
Rumah Sakit
Terminal Bus
Sekolah

Puskesmas
Stasiun Kereta Api
Rumah Ibadah
Gedung/Kantor
Pelayanan Umum

Dimensi Produk:

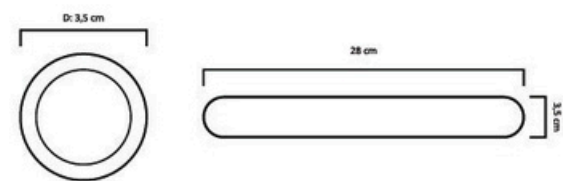

Bollard Taynek

BL 432

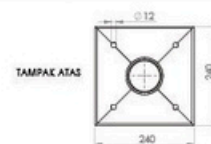

TAMPAK ISOMETRIK

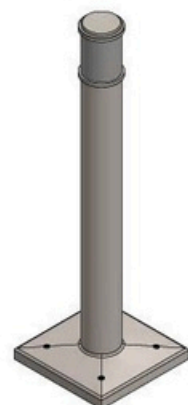

*dalam satuan mm (milimeter)

INLET DRAINASE MANHOLE COVER

Tutup Manhole SKYANDESIT 1

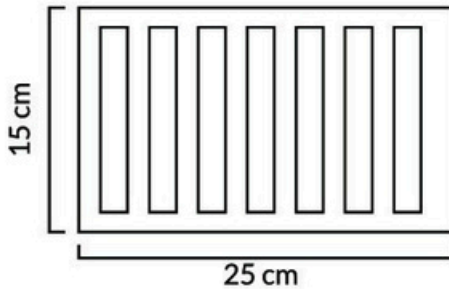
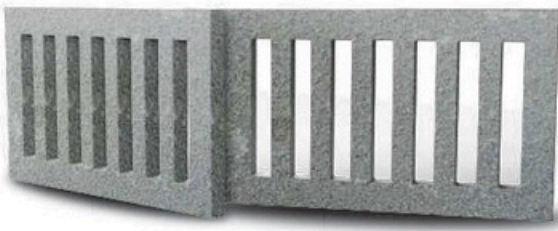

Tutup Manhole SKYANDESIT 2

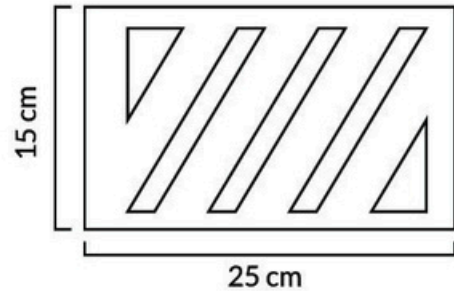

Drainase merupakan salah satu cara pembuangan kelebihan air yang tidak di inginkan pada suatu daerah. serta cara penanggulangan akibat kelebihan air, dalam sistem drainase di perlukan bangunan penunjang, salah satunya yaitu bangunan inlet. Inlet menerima air permukaan dan menyalurkannya ke saluran drainase. Bila datangnya musim hujan, hampir terjadi banjir atau genangan di ruas-ruas jalan perkotaan. Salah satu faktor terjadinya genangan adalah curah hujan yang tinggi, peningkatan, kurangnya kapasitas saluran drainase dan desain bukaan lubang (inlet) yang tidak sesuai.

Preview Inlet Drainase Manhole Cover



KOMPOSITE MULUT AIR



KOMPOSITE MULUT AIR

- DIMENSI TUTUP/PENUTUP
- DIAMETER SALURAN
- DIMENSI RANGKA
- 50 X 20 CM
- 27 CM
- 54 X 24 CM

- TINGGI KESELURUHAN : 34 CM
- DIAMETER PIPA : 6 INCH



KOMPOSITE MULUT AIR

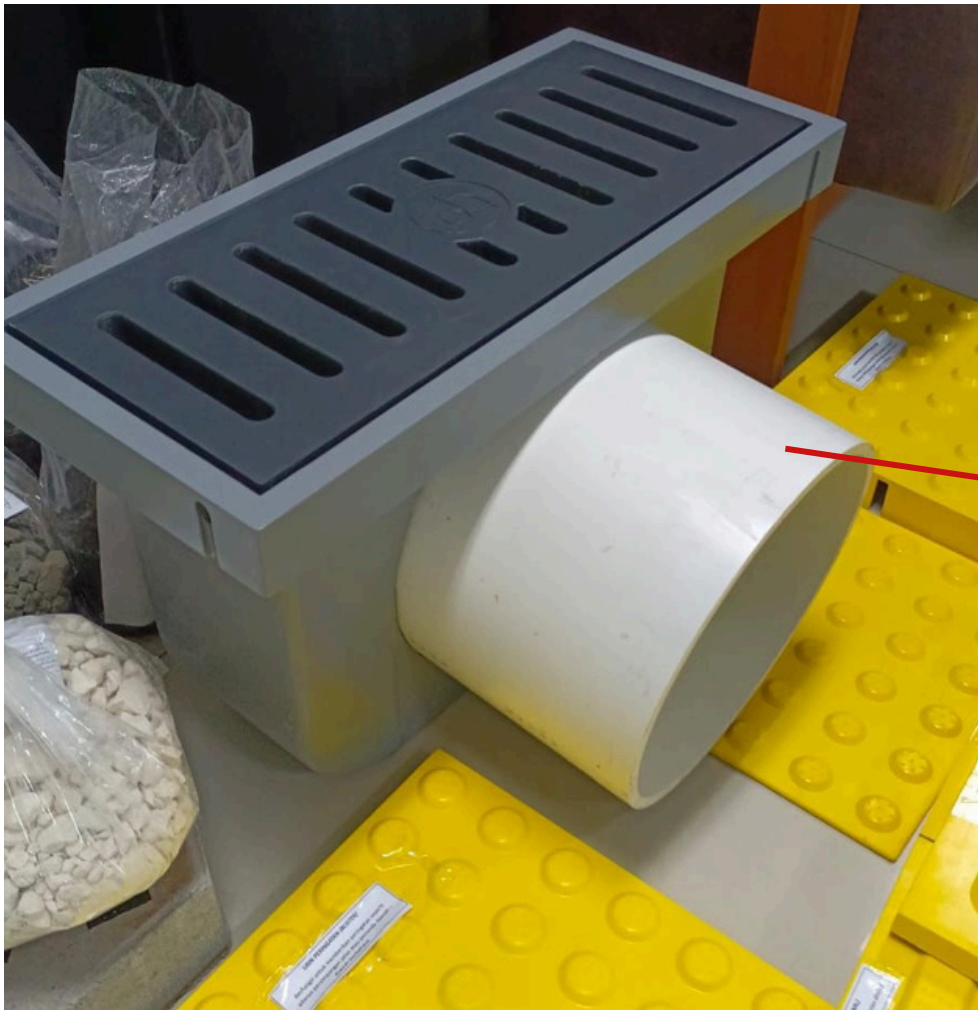

KOMPOSITE MULUT AIR

- DIMENSI TUTUP/PENUTUP
 - DIAMETER SALURAN
 - DIMENSI RANGKA
- 50 X 20 CM
 - 27 CM
 - 54 X 24 CM

- TINGGI KESELURUHAN : 34 CM
- DIAMETER PIPA : 6 INCH

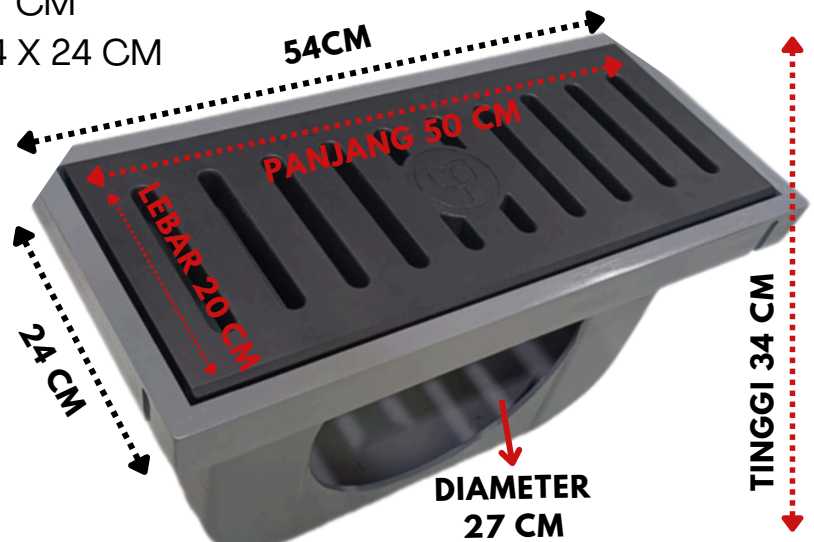

KOMPOSITE MULUT AIR



KOMPOSITE MULUT AIR

- DIMENSI TUTUP/PENUTUP
 - DIAMETER SALURAN
 - DIMENSI RANGKA
- 50 X 20 CM
 - 27 CM
 - 54 X 24 CM

- TINGGI KESELURUHAN : 34 CM
- DIAMETER PIPA : 6 INCH

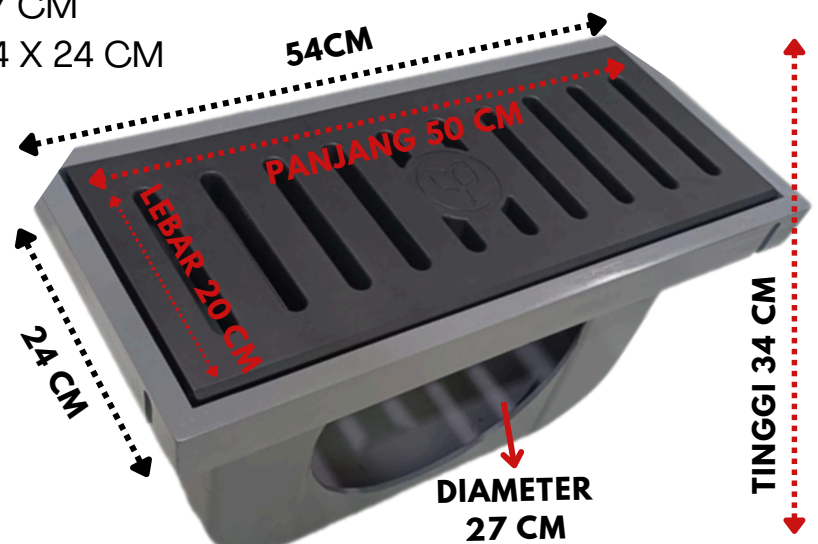

KOMPOSITE MULUT AIR



KOMPOSITE MULUT AIR

- DIMENSI TUTUP/PENUTUP
 - DIAMETER SALURAN
 - DIMENSI RANGKA
- 50 X 20 CM
 - 27 CM
 - 54 X 24 CM

- TINGGI KESELURUHAN : 34 CM
- DIAMETER PIPA : 6 INCH

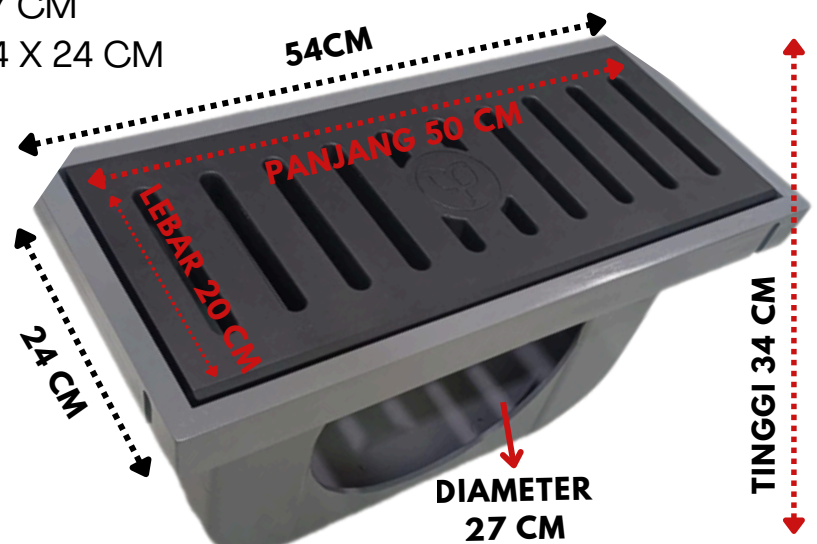

KOMPOSITE MULUT AIR

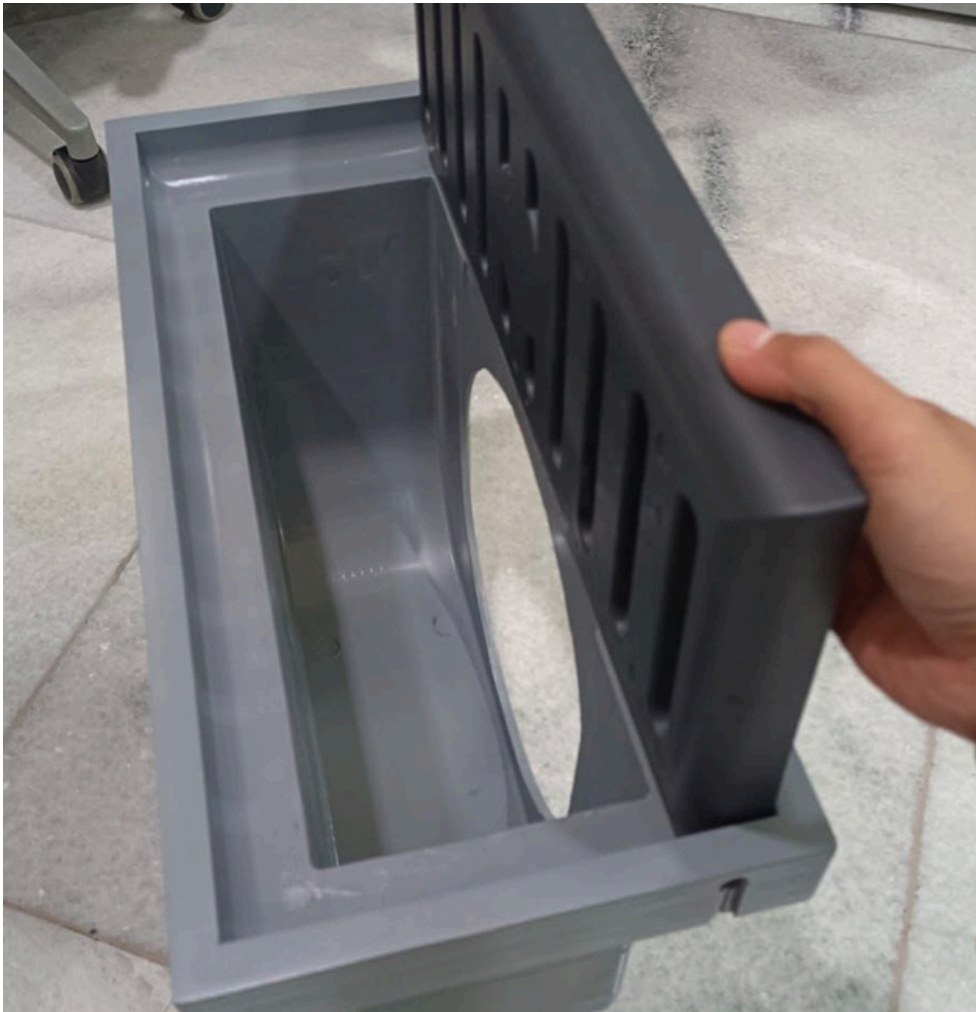

KOMPOSITE MULUT AIR

- DIMENSI TUTUP/PENUTUP
 - DIAMETER SALURAN
 - DIMENSI RANGKA
- 50 X 20 CM
 - 27 CM
 - 54 X 24 CM

- TINGGI KESELURUHAN : 34 CM
- DIAMETER PIPA : 6 INCH

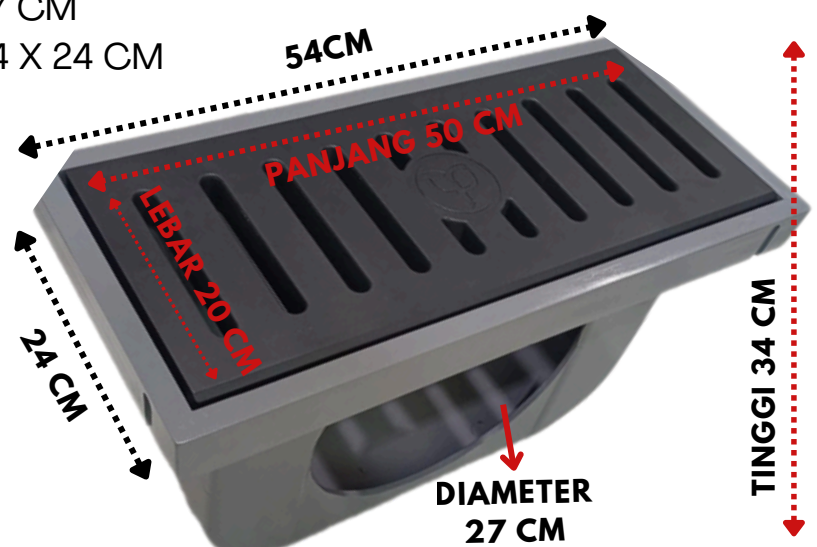

OXA WT 100

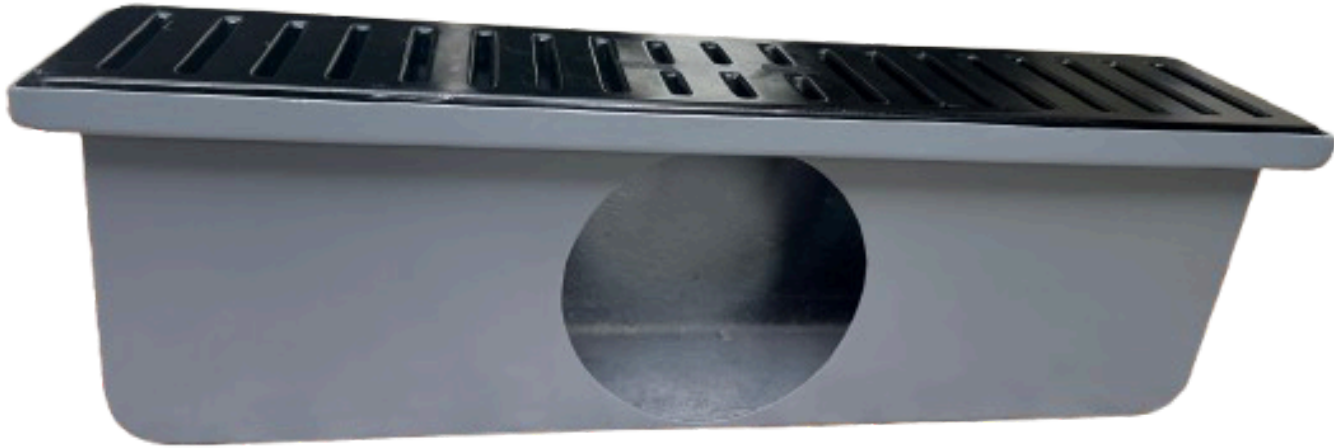

BAHAN KOMPOSITE FIBER WATER TRAP 100 CM

- Panjang Saluran • 100 CM
- Lebar Saluran • 22 CM
- Kedalaman Saluran • 30 CM
- Ketebalan Penutup • 2 CM

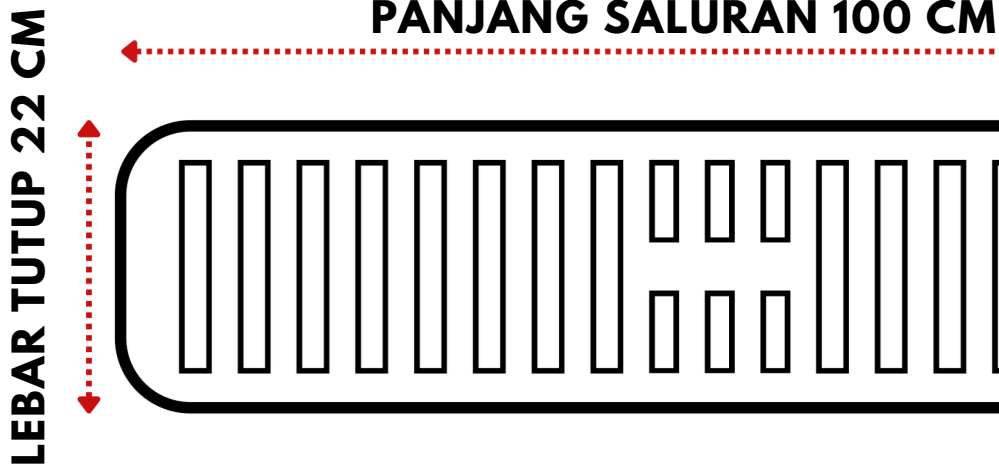

OXA WT 100



BAHAN KOMPOSITE FIBER WATER TRAP 100 CM

- Panjang Saluran
 - Lebar Saluran
 - Kedalaman Saluran
 - Ketebalan Penutup
- 100 CM
 - 22 CM
 - 30 CM
 - 2 CM

LEBAR TUTUP 22 CM

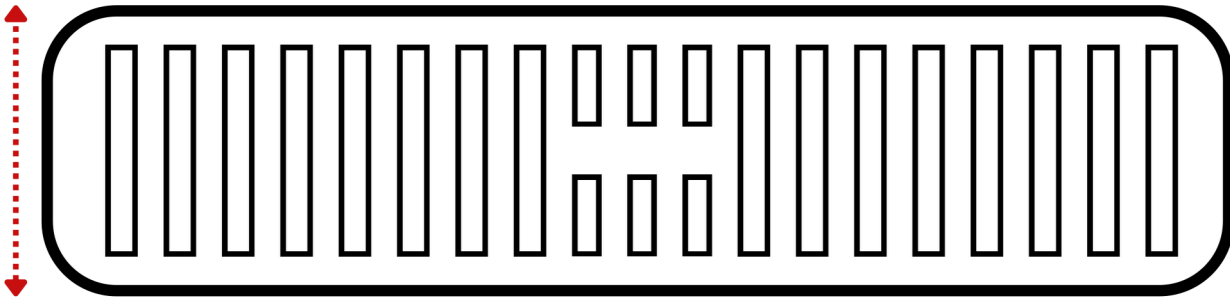

OXA WT 100



BAHAN KOMPOSITE FIBER WATER TRAP 100 CM

- Panjang Saluran • 100 CM
- Lebar Saluran • 22 CM
- Kedalaman Saluran • 30 CM
- Ketebalan Penutup • 2 CM

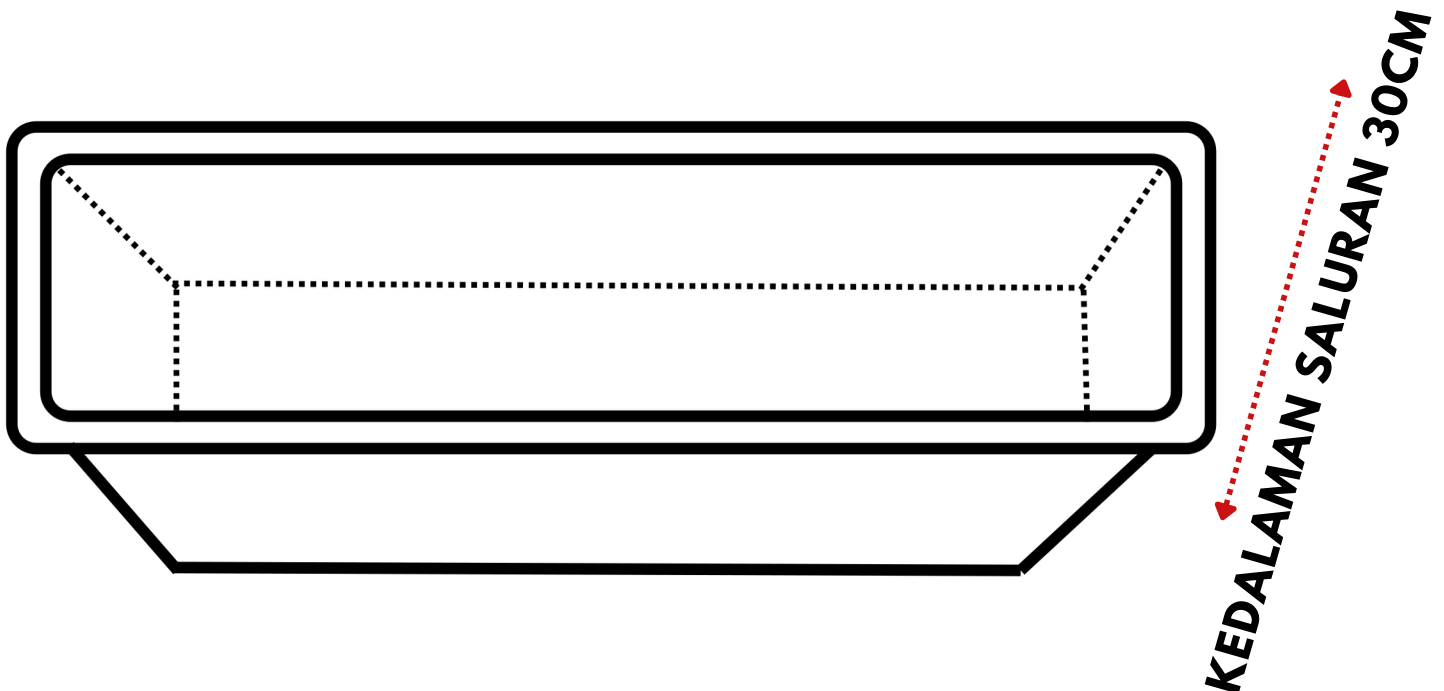

OXA WT 100



BAHAN KOMPOSITE FIBER WATER TRAP 100 CM

- Panjang Saluran
 - Lebar Saluran
 - Kedalaman Saluran
 - Ketebalan Penutup
- 100 CM
 - 22 CM
 - 30 CM
 - 2 CM

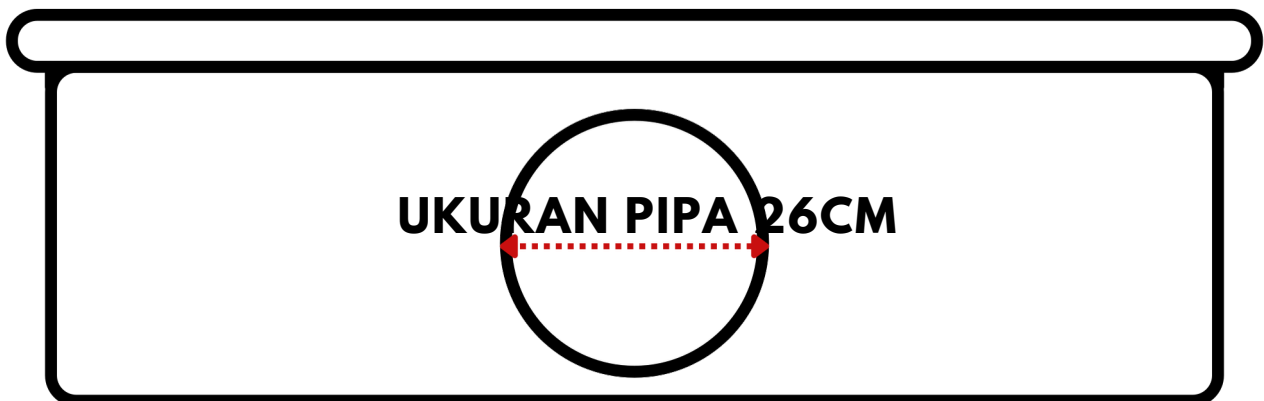

OXA WT 100



BAHAN KOMPOSITE FIBER WATER TRAP 100 CM

Panjang Saluran	100 CM
Lebar Saluran	22 CM
Kedalaman Saluran	30 CM
Ketebalan Penutup	2 CM

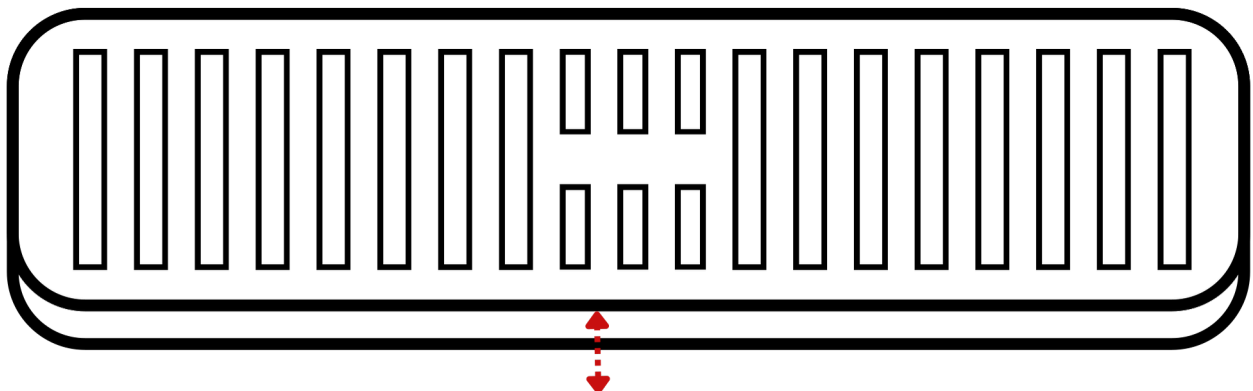

KETEBALAN PENUTUP 2 CM



OXA
JAYA INDONESIA

UBIN PENGARAH BAHAN COMPOSITE

TACTILE PAVING

UV RESISTANT COMPOSITE

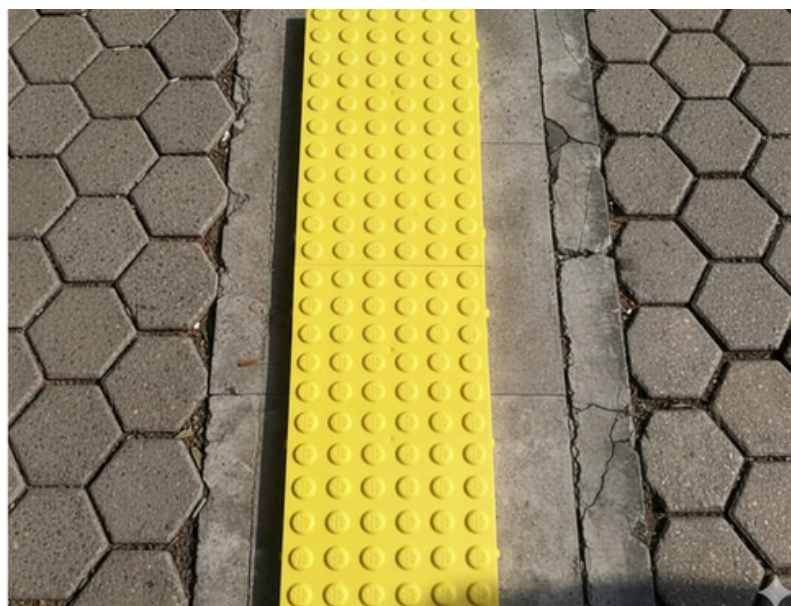
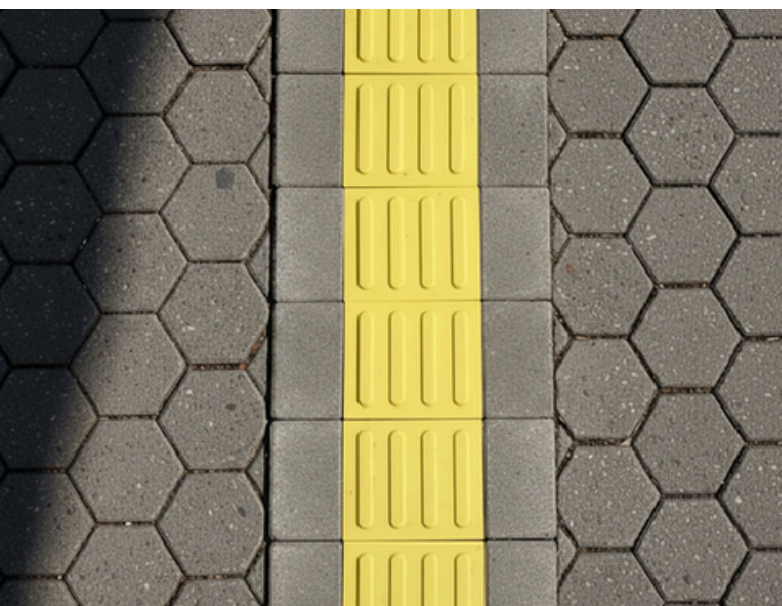

KEUNGGULAN

terbuat dari komposit tahan ultraviolet, baik digunakan di outdoor area memudahkan kaum distabilitas menentukan langkah dan arah yang tepat.

Aplikasi	penanda trotoar penjalan kaki distabilitas
Sambungan	Terdapat celah sambungan sekitar 1mm. Kelebihan pemasangan sangat pemasangan.

SPESIFIKASI PRODUK :

Dimensional (cm)	Warna	Berat (kg)	Ketahanan
30x30x4	Kuning	0.5-0.75	Anti UV



OXA
JAYA INDONESIA

TACTILE PAVING

BELAKANG

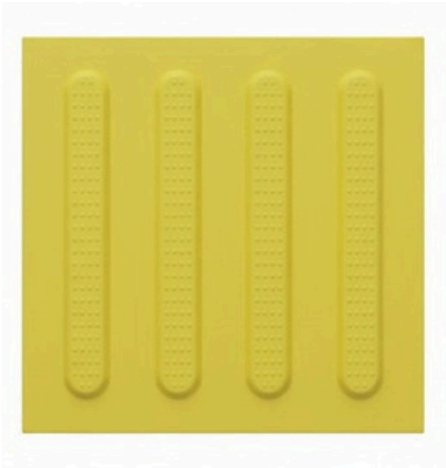

contact info:

Telp: 0812 9301 4188

Oxa Jaya Indonesia

E-mail: Sales@oxajayaindonesia.com



OXA

PT Oxa Jaya Indonesia

KOMPOSITE CURVE

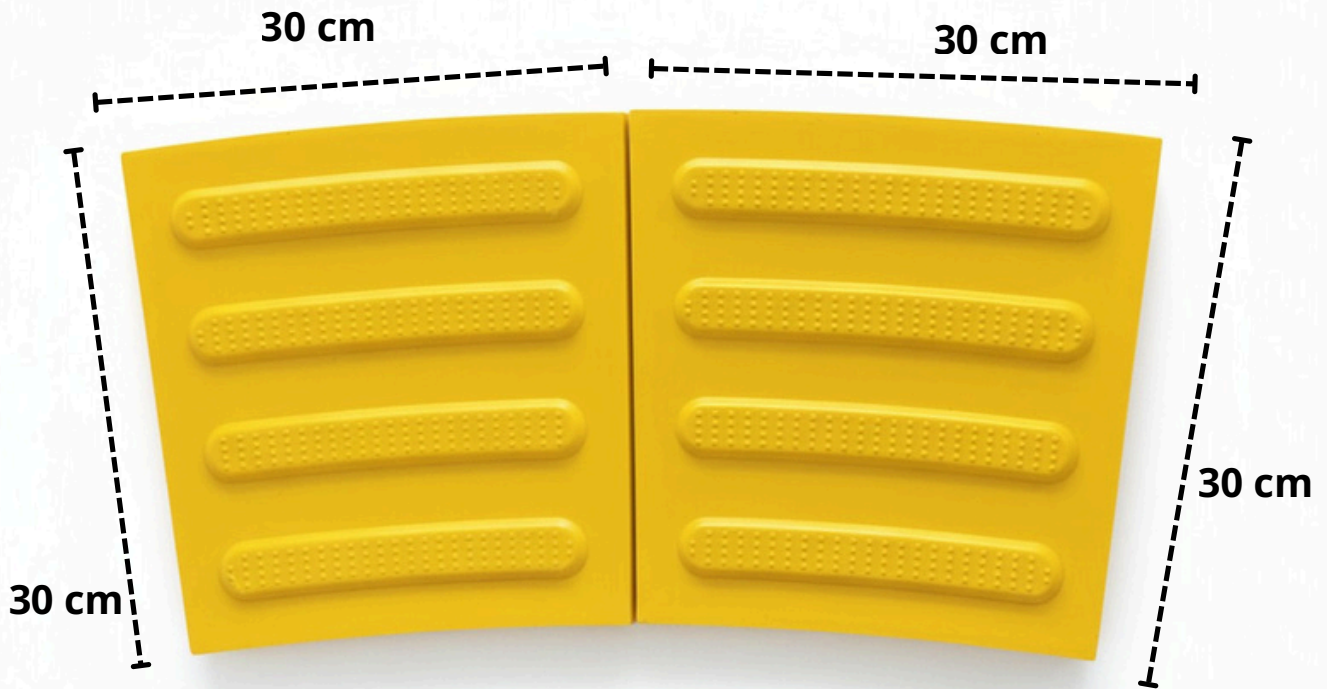

OXA - C15
Curve : 15°

OXA - C7,5
Curve : 7,5°



Polymer composite guiding block (satuan)

Type Line

Type guiding block : Line
panjang block: 28 cm
lebar block: 3 cm
tinggi block: 0,7 cm
panjang baut : 4 cm

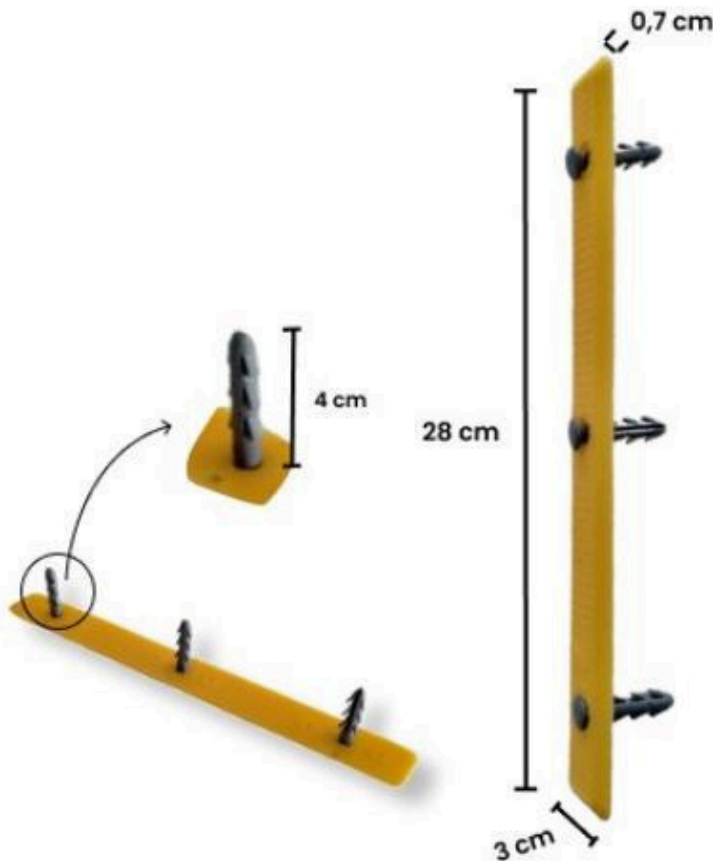

Type dot

Type guiding block : dot
diameter dot : 2,8 cm
diameter baut : 1,15 cm
tinggi dot: 0,5 cm
panjang baut : 4 cm

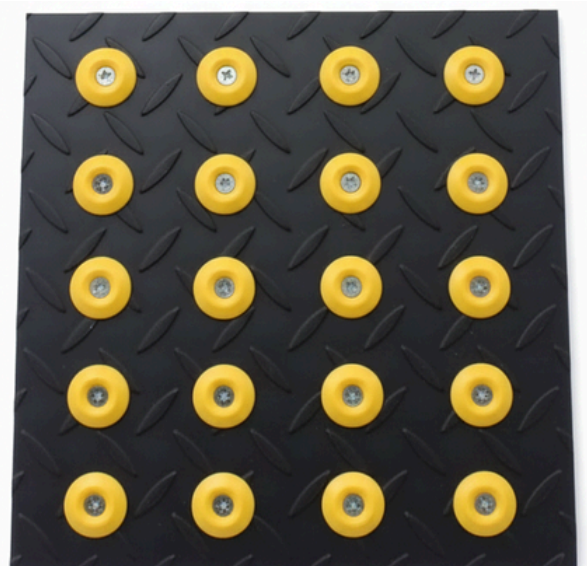
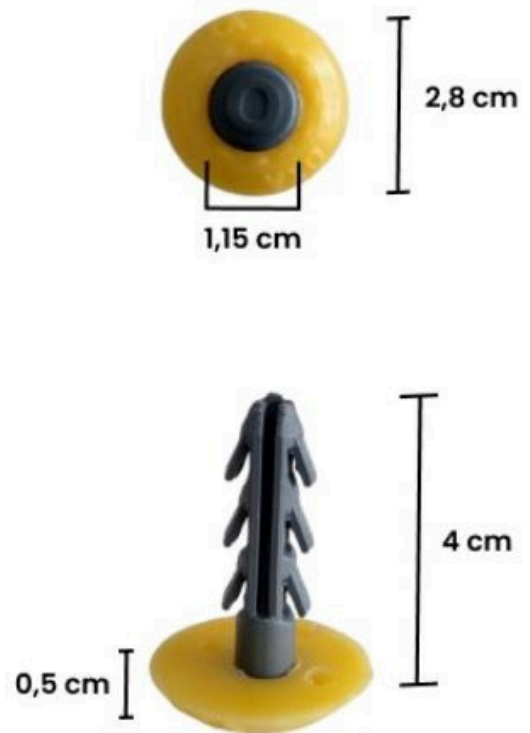



OXA

PT Oxa Jaya Indonesia

POLYMER KOMPOSITE

BAHAN : POLYMER KOMPOSITE

Dimensi penutup : 60 cm x 60 cm

Ketebalan penutup : 4 cm Dimensi
dudukan : 70 cm x 70 cm

Ketebalan dudukan : 4 cm

Dimensi lubang : 60 cm x 60 cm

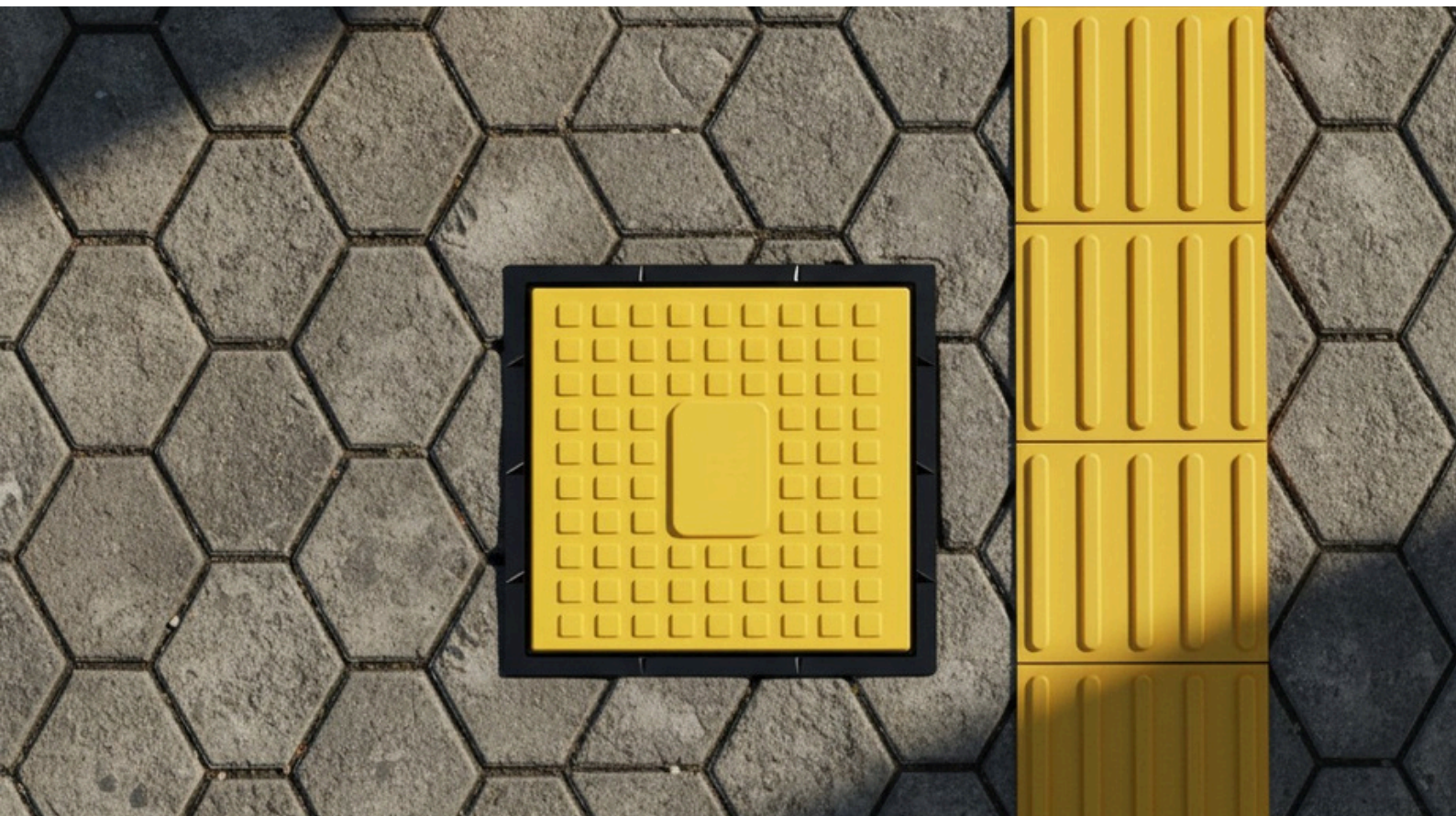
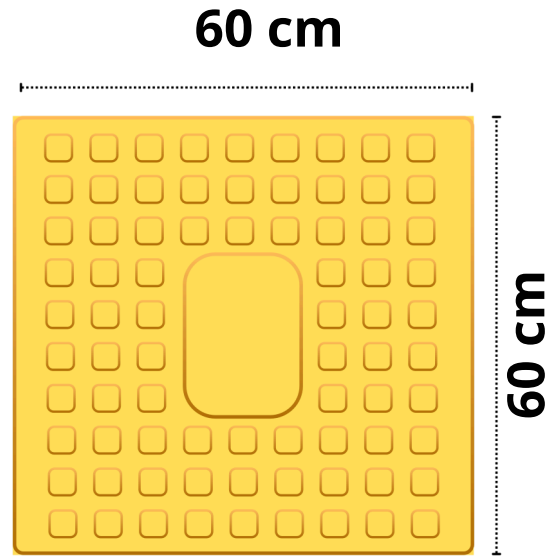
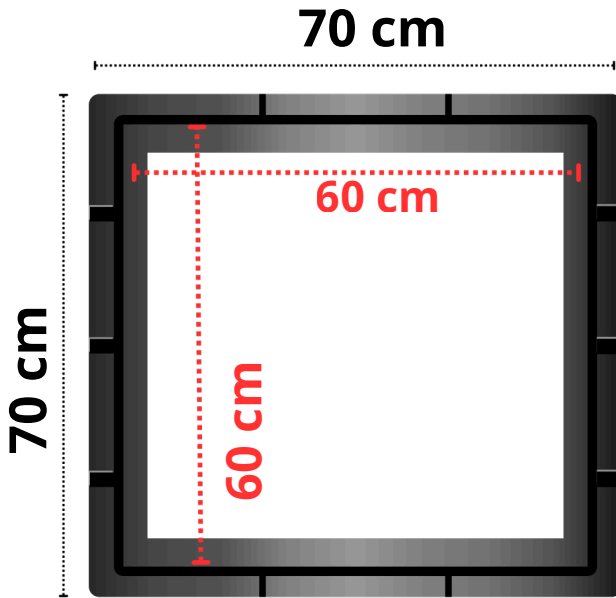

POLYMER KOMPOSITE

BAHAN : POLYMER KOMPOSITE

Dimensi penutup : 76 cm x 56 cm

Ketebalan penutup : 4 cm

Dimensi dudukan : 89 cm x 69 cm

Ketebalan dudukan : 4 cm

Dimensi lubang : 72 cm x 53 cm

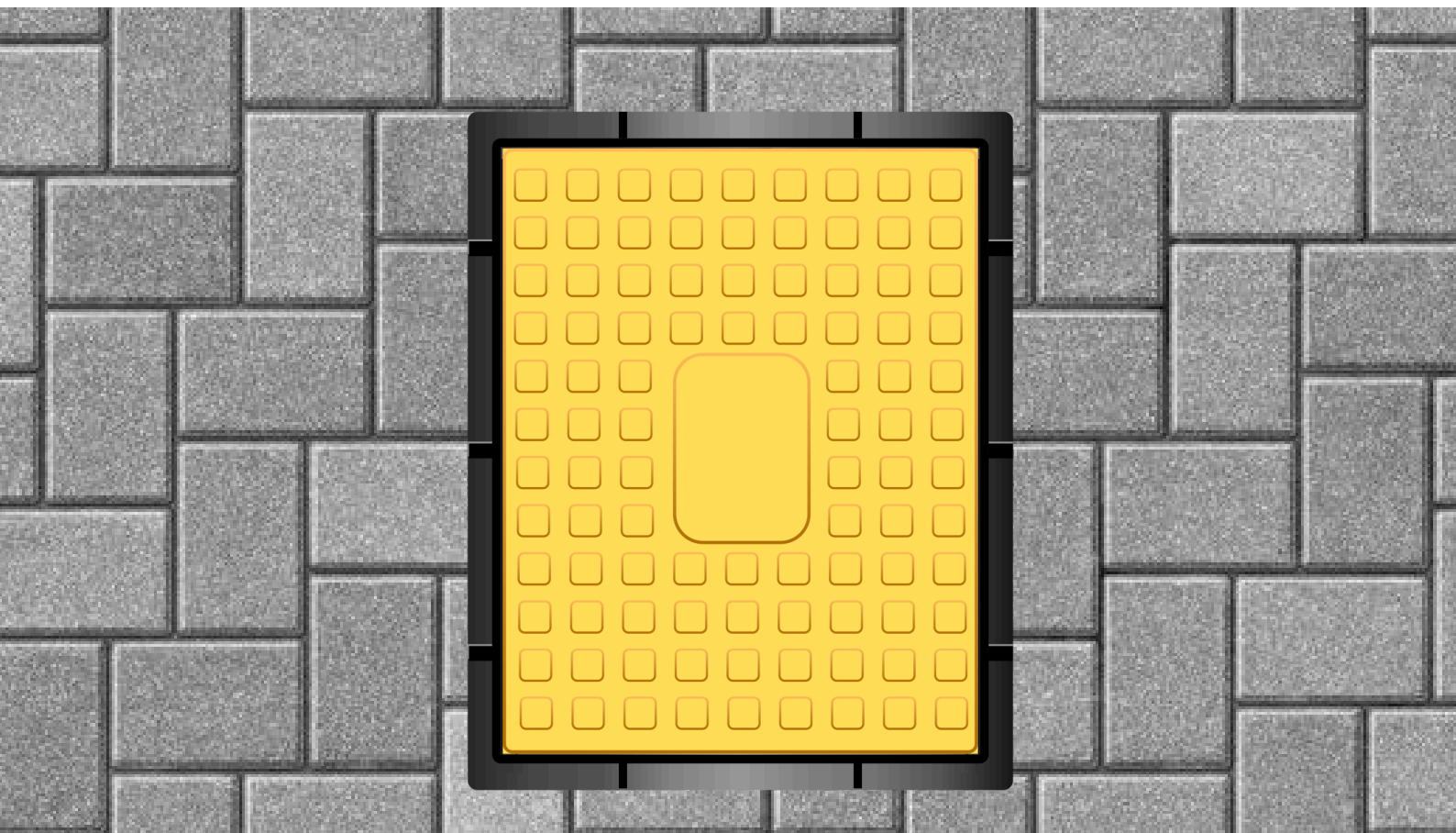
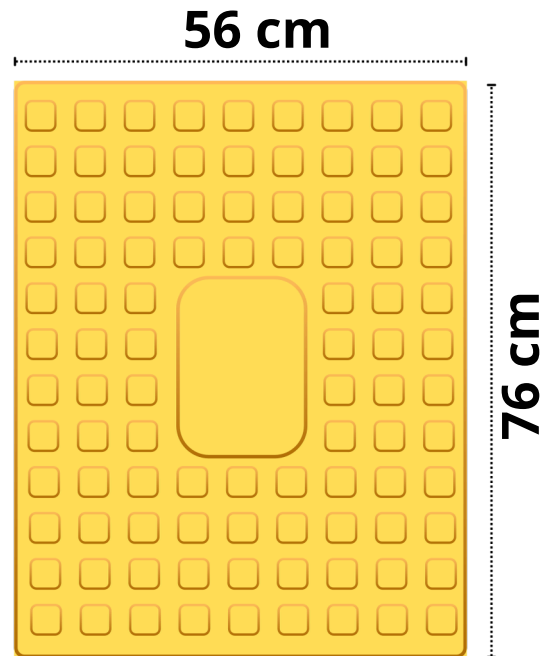
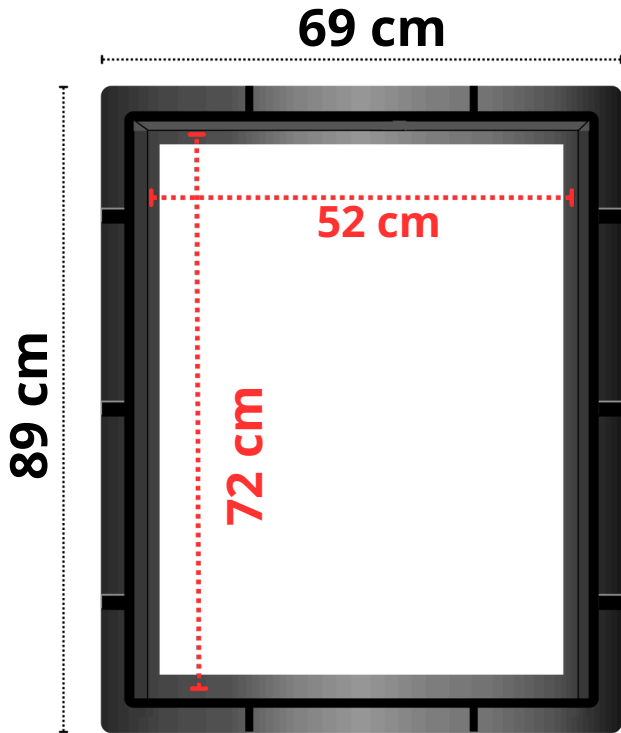

STREET BOX COVER CAST IRON

NO	NAMA	QTY	MATERIAL
1	Body	1	Gray Cast Iron FC 250
2	Cover Plate	1	Gray Cast Iron FC 250
3	Bolt ¼ x1½	1	Steel
4	Nut ¼	1	Steel

PRODUCT TYPE	Dimension (mm)					PKG (Pcs)	NW (Kg)
	A	B	C	D	E		
Street Box 2	70	120	130	83	155	8	1,88

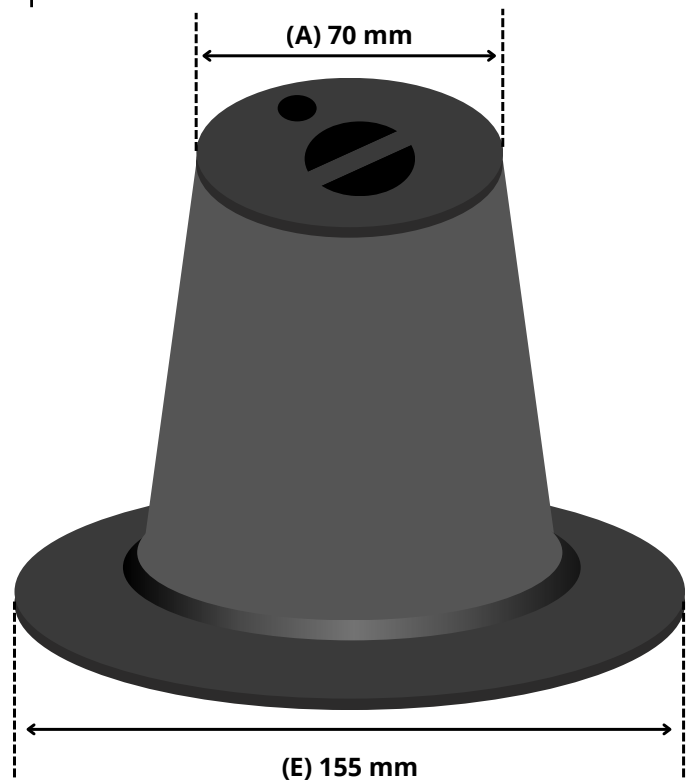
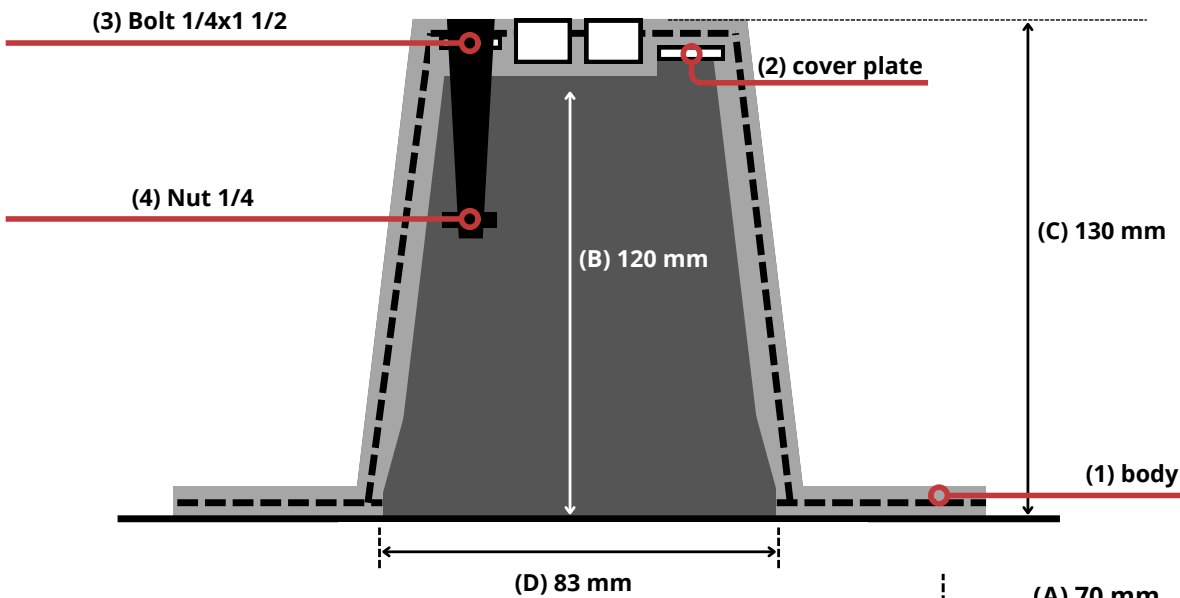
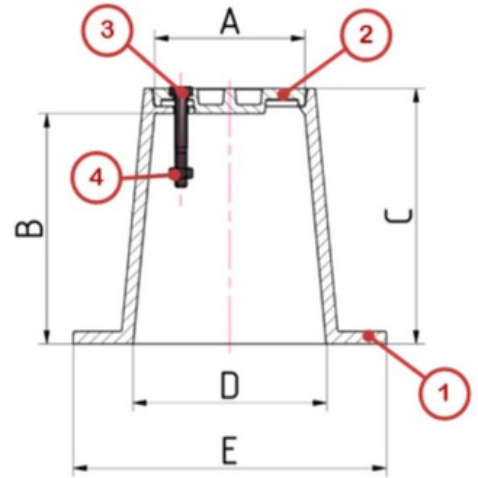



OXA

PT Oxa Jaya Indonesia

BOLLARD

80 cm



OXA KB 301

Dibuat dengan Bahan Polymer Komposit. OXA KB 301 adalah Bollard yang berfungsi sebagai pembatas di pedestrian yang serbaguna dan tahan lama sesuai kebutuhan di lapangan.



OXA

PT Oxa Jaya Indonesia

KOMPOSITE MARKA JALAN

Nama Barang : komposite marka jalan

Bahan : Polymer composite

Warna available : Kuning , Putih

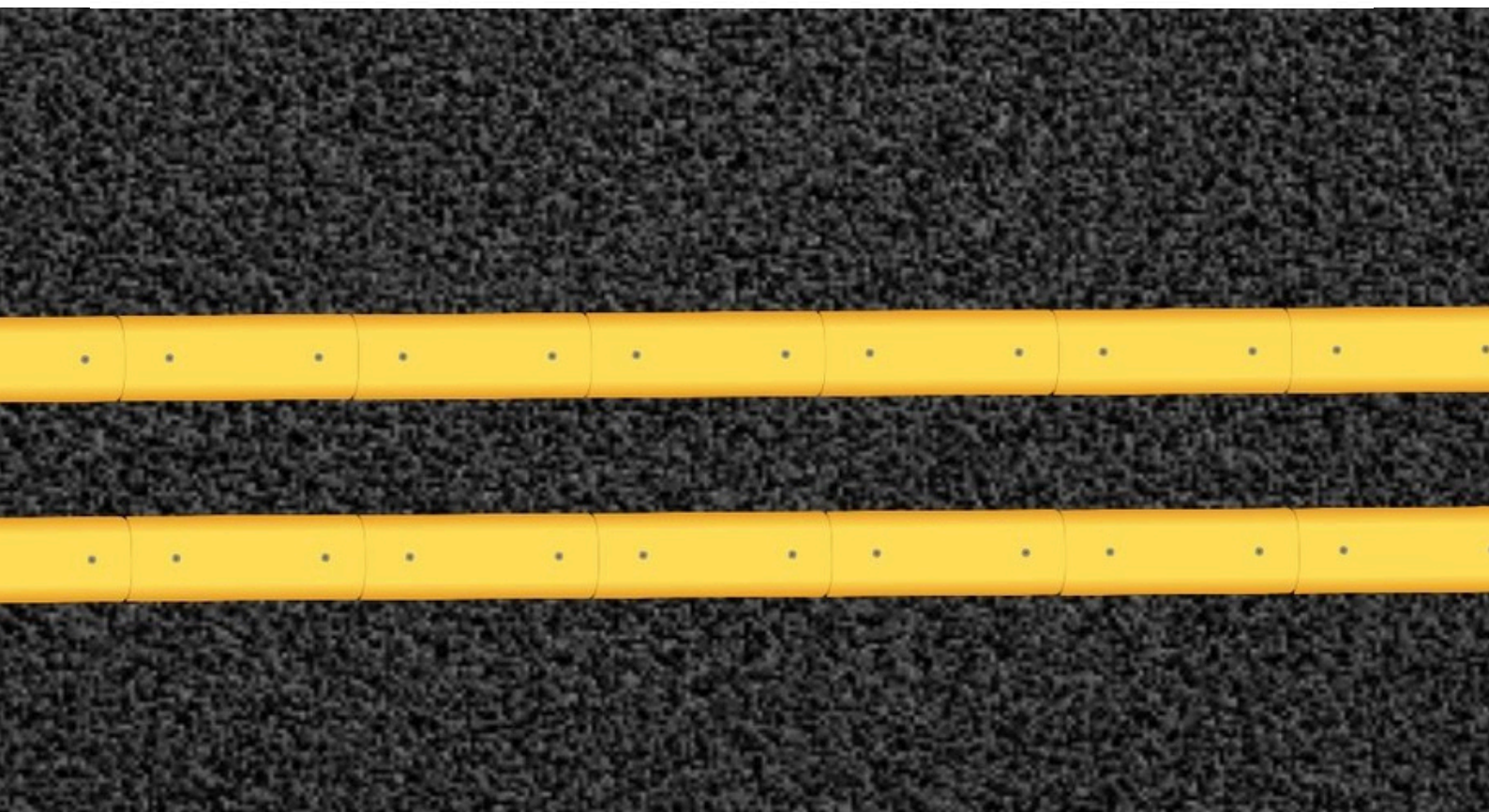
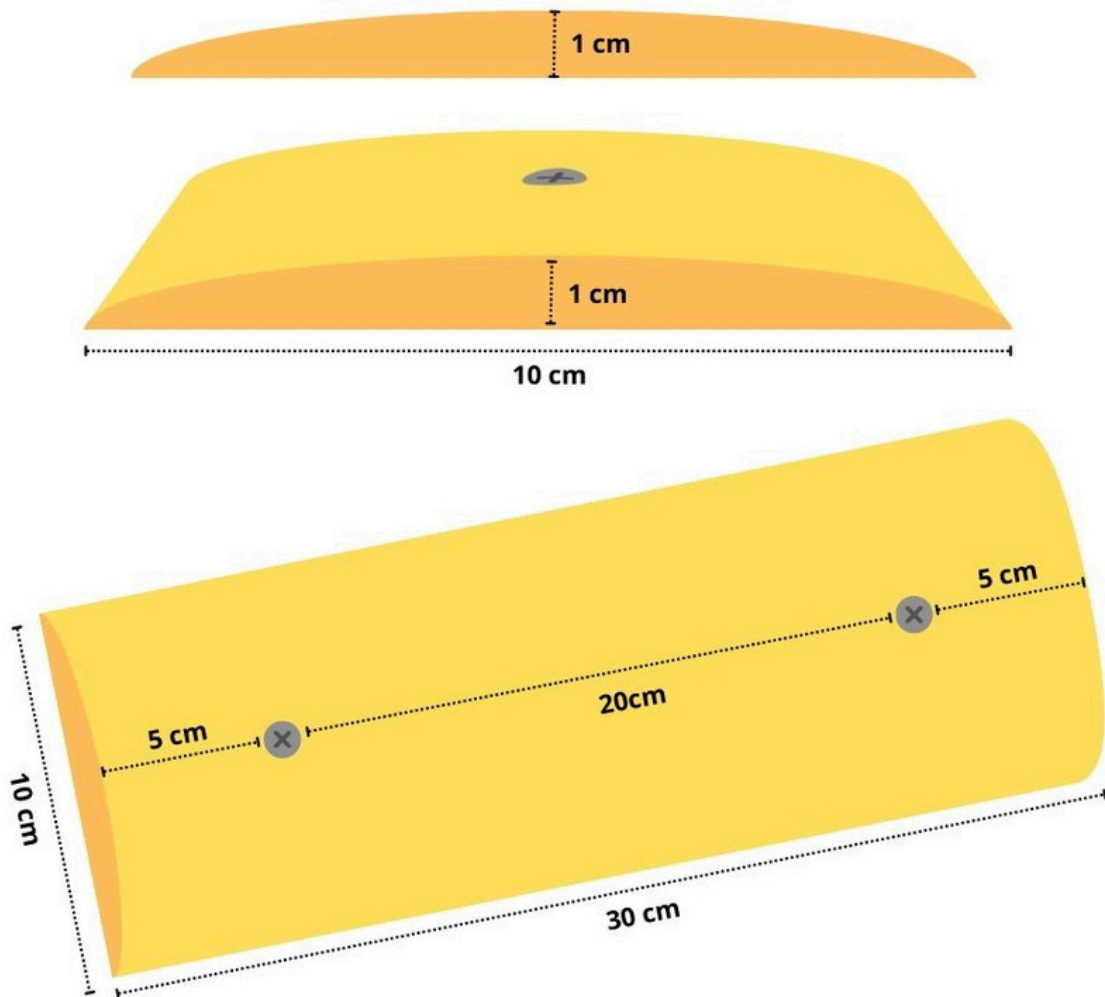



OXA

PT Oxa Jaya Indonesia

LAMPIRAN POLA JALANAN

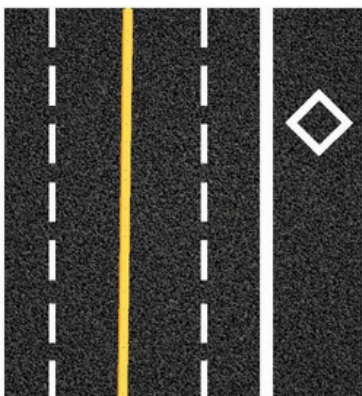
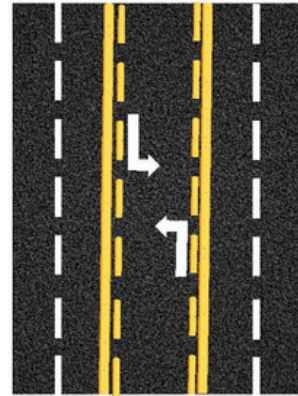
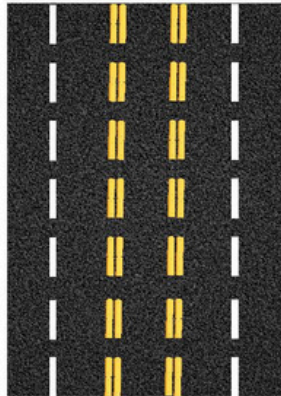
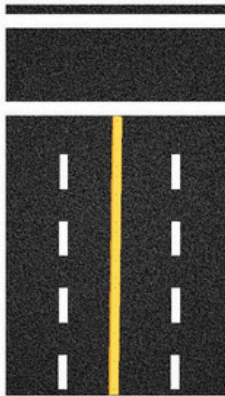
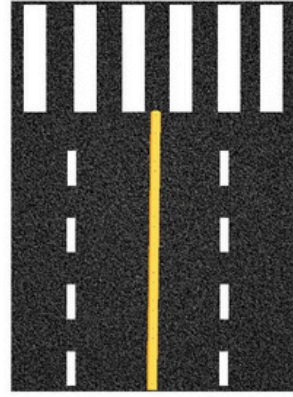
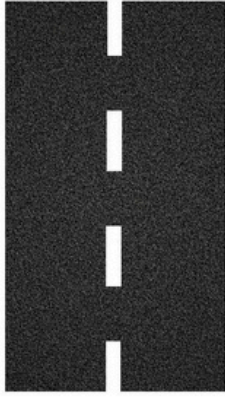
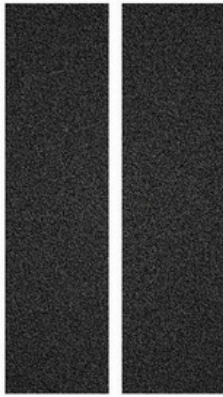
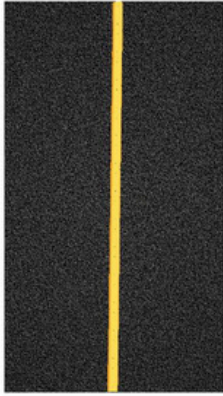

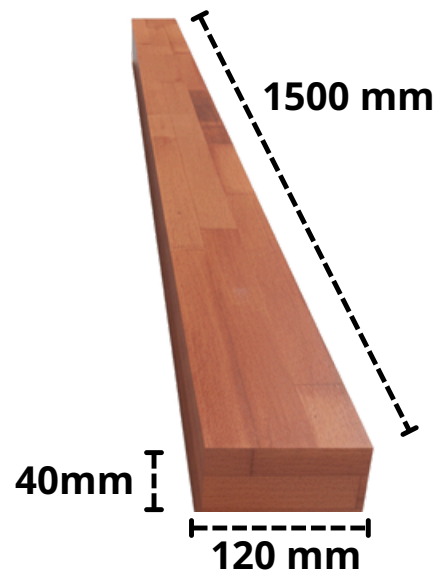
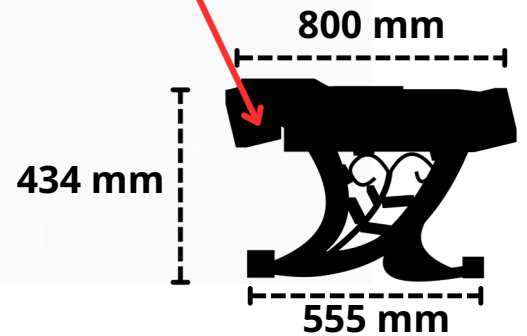
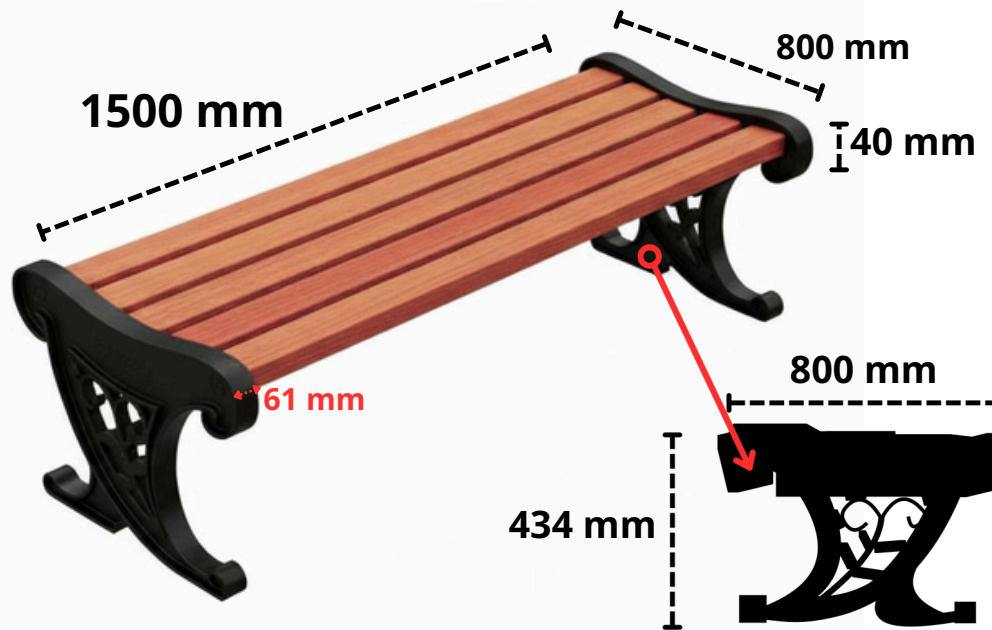

KURSI TAMAN KAYU SOLID

Ukuran kayu suren solid Laminated, P (per buah kayu)

PxLxT : 1500 x 120 x 40 (mm)

Ukuran rangka kaki kursi taman (mm)

Lebar atas : 800 mm

Lebar bawah : 555 mm

Tinggi : 434 mm, Tebal : 61 mm

Berat besi kiri kanan : 60 kgs.

Jenis kayu suren solid laminated

Rangka kaki kursi Taman : Iron Cast (Besi Cor)





Engineering-Stone, 20 mm



Batu Gunung Kerinci

Engineering-Stone, structured surface, 60x60x2 cm



Batu Gunung Kerinci
Volcanic



Batu Gunung Kerinci
Ash



Batu Gunung Kerinci
Desert



Batu Gunung Kerinci

Engineering-Stone, structured surface, 60x60x2 cm



Batu Gunung Kerinci
Savanna



Batu Gunung Kerinci
Sand



Engineering-Stone, 20 mm



Batu Gunung Lawu

Engineering-Stone, structured surface, 60x60x2 cm



Batu Gunung Lawu
Night

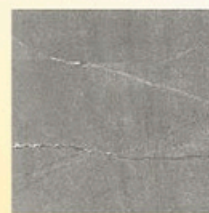

Batu Gunung Lawu
Day



Batu Gunung Merapi

Engineering-Stone, structured surface, 60x60x2 cm



Batu Gunung Merapi
Dark



Batu Gunung Merapi
Light

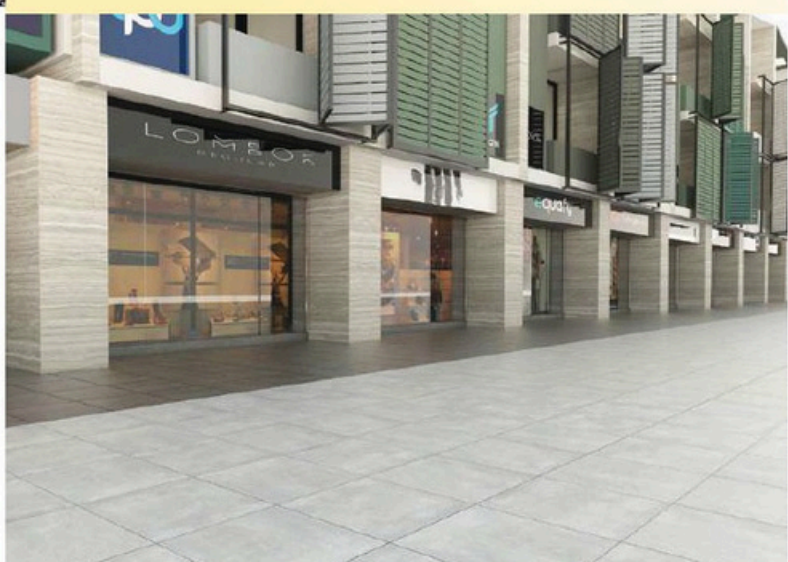

Engineering-Stone, 20 mm



Batu Gunung Singgalang

Engineering-Stone, structured surface, 60x60x2 cm



Batu Gunung Singgalang Stone



Batu Gunung Singgalang Earth



Batu Gunung Puncak Jaya

Engineering-Stone, structured surface, 60x60x2 cm



Batu Gunung Puncak Jaya Ash



Batu Gunung Puncak Jaya Graphite



Engineering-Stone, 20 mm



Batu Gunung Sumantri

Engineering-Stone, structured surface, 60x60x2 cm

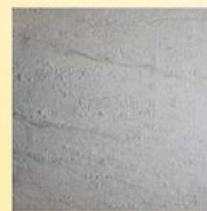

Batu Gunung Sumantri Perla



Batu Gunung Sumantri Grigio



Batu Gunung Puncak Mandala

Engineering-Stone, structured surface, 60x60x2 cm



Batu Gunung Puncak Mandala Grey

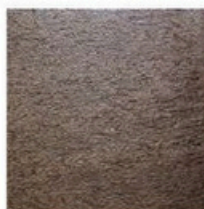

Batu Gunung Puncak Mandala Brown





Engineering-Stone, 20 mm



Batu Gunung Puncak Trikora

Engineering-Stone, matt surface, 30x30x2 cm



Batu Gunung Puncak Trikora Avorio



Batu Gunung Puncak Trikora Grigio



Batu Gunung Puncak Trikora Bruno

Batu Gunung Semeru

Engineering-Stone, matt surface, 30x30x2 cm



Batu Gunung Semeru Sabana



Batu Gunung Semeru Tierra

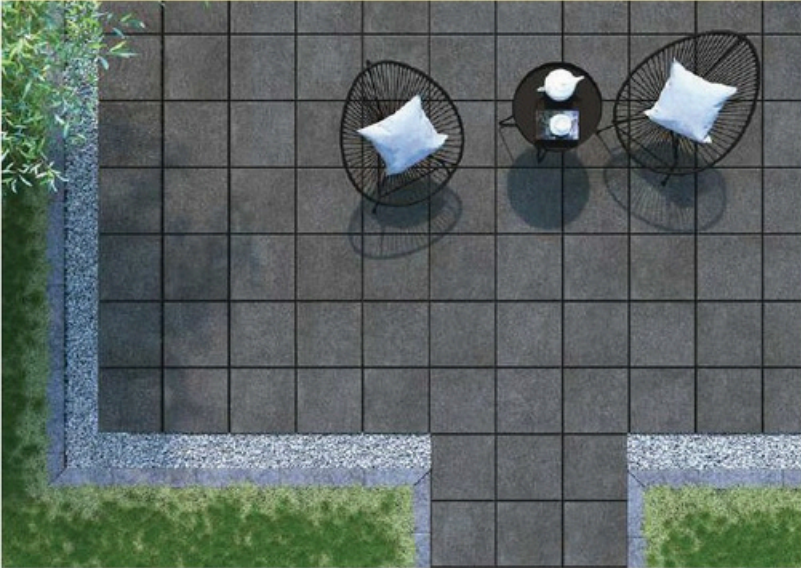

Engineering-Stone, 20 mm



Batu Gunung Rinjani

Engineering-Stone, structured surface, 30x30x2 cm



Batu Gunung Rinjani Perla



Batu Gunung Rinjani Grigio



Batu Gunung Rinjani Charcoal

Batu Gunung Sanggar

Engineering-Stone, matt surface, 30x30x2 cm



Batu Gunung Sanggar Charcoal



Batu Gunung Lajimojong

Engineering-Stone, matt surface, 30x30x2 cm



Batu Gunung
Lajimojong Acero



Batu Gunung
Lajimojong Antracite

The Lajimojong collection presents 3 accessories in the form: Lineartopping (15x30cm), Cornertopping (15x15cm), and Steptile (30x30cm) These are outdoor tile innovations that complement the hardscape garden concept with natural motifs. For the use of stairs in parks or pedestrian areas that have different height levels, Lajimojong provides Steptile accessories

ACCESSORIES Batu Gunung Lajimojong



NTCB8054CR
Cornertopping
Lajimojong Antracite



OTLB8054CR
Lineartopping
Lajimojong Antracite

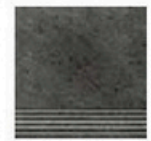

RTTB8054CR
Steptile
Lajimojong Antracite



NTCB8053CR
Cornertopping
Lajimojong Acero



OTLB8053CR
Lineartopping
Lajimojong Acero



RTTB8053CR
Steptile
Lajimojong Acero

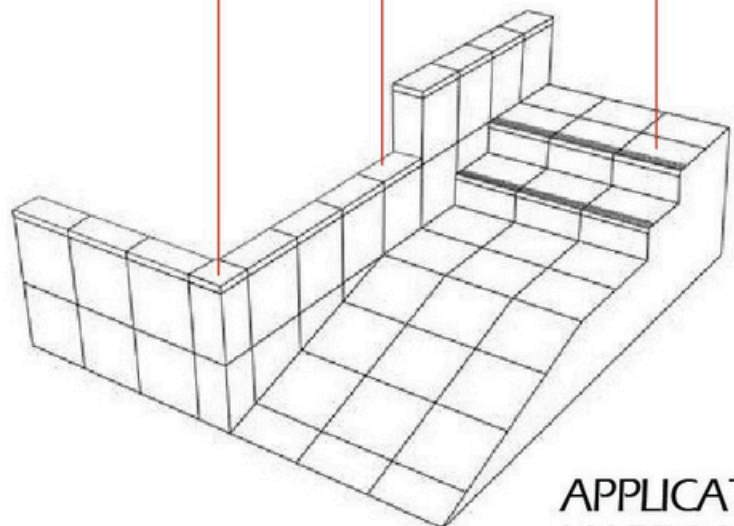

APPLICATION
HARDSCAPE

TECHNICAL CHARACTERISTICS & PACKING DATA

TECHNICAL CHARACTERISTIC	TEST METHOD OR AS PER NORM	ISO 13006 REQUIREMENT	ROMANGRANIT
Length and Width	ISO 10545-2	± 0.6%	± 0.10%
Side Straightness	ISO 10545-2	± 0.5%	± 0.10%
Rectangularity	ISO 10545-2	± 0.6%	± 0.10%
Centre & Edge Curvature	ISO 10545-2	± 0.5%	- 0.15% to + 0.25%
Warpage	ISO 10545-2	± 0.5%	± 0.25%
Thickness	ISO 10545-2	± 5.0%	± 4.0%
Water Absorption	ISO 10545-3	Group B1a ≤ 0.5%	- 0.15% to + 0.25%
Modulus of Rupture	ISO 10545-4	Group B1a 35 Ind. Min. 32 N/mm	≥ 40 N/mm ²
Crazing Resistance	ISO 10545-11	Required	Resistant
Chemical Resistance	ISO 10545-13	Minimum Class GB	Minimum Class GB
Stain Resistance	ISO 10545-14	Minimum Class III	Minimum Class IV
Abrasion Resistance	ISO 10545-7	Group I to V	Group III to V

- The colors illustrated in this brochure are produces near to actual colors.
- Slight variations of shades/colours and surface finishes are inherent due to the nature of ceramic tile production process.

STANDARD PACKING DATA

Factory	Type	Size	Pieces/Box	Approx. Sqm/box	Approx. Weight Kg/box	Bboxes/ Pallet	Pallet/ Container	Approx. Weight Kg/pallet	Approx. Weight Tonne/Cont.	Approx. Sqm/Cont.	Approx. Box/Cont.
RCI	Rectified	HARDROCK 60x60	2	0,72	34	32	19	1113	21.1	438	608
RCI	Rectified	HARDROCK 30x30	6	0,54	25.5	48 24	17 1	1249	21.2	454	840

- The governing sizes and weights are subject to usual variations expected of fired ceramic productions.
- Packing information may vary depending on spesification of each motif and size.

60x60

dForaker

dFuji

dJuparana

dKilimanjaro

dMakaru

dTasman

dVesuvio

dWellington

30x30

dCandi

dLavastone

dPlutonic

dTambora

dTidore



GREEN SUKABUMI STONE

Green Sukabumi Stone (Pedra Hijau Verde) is the one of world premium class of natural stone pool tiles since its has unique green color and this stone only can found in Indonesia



SPLIT FACE (BRUTA)

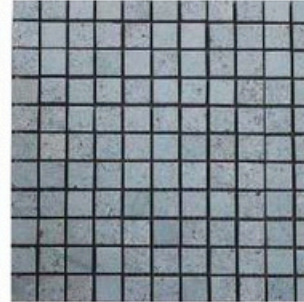

MOSAIC (MOSAICO)

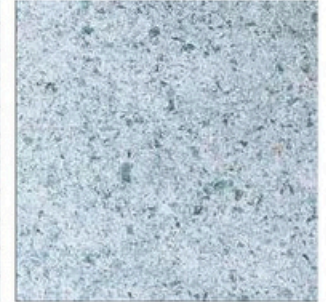

SAWN CUT (LISA)

Available Cutting Size : 100x100x10, 100x200x10, 200x200x10, 300x600x10 mm, 301x301 mosaic in mesh

Finishing : Sawn Cut, Honed, Split Face, Brush



VOLCANIC LAVASTONE

Volcanic Lavastone also known as pedra hitam preta is a volcanic lavastone and of most populer stone because its used as material for Borobudur Temple the world biggest Buddhist temple.



BLACK LAVASTONE - HONED

Available Cutting Size : 100x100x10, 100x200x10, 300x300, 300x600, mm with any thickness, 301x301 mm mosaic in mesh



BLACK LAVASTONE - WALL CLADDING

Finishing : Sawn Cut, Honed, Split Face, Etched, Bush Hammered



SANDSTONE

A beautiful fine grained stone that has general characteristic in creamy white base colour, high stone density, good abrasion resistance, small grained (Palimo Blonde) and uniform creamy white (Palimo White).



GOLDEN PALIMO

Available Cutting Size : 300x300, 300x600, 400x600, 600x600 (mm) with any thickness



WHITE PALIMO

Finishing : Sawn Cut, Honed, Bush Hammered, Split Face



LIMESTONE

Limestones are a very finely grained stone with a high calcite content also containing halite and gypsum minerals. Some stones contain siliceous crystalline granules.



CLASSIC WHITE

Available Cutting Size : 300x600, 400x400, 400x600, 600x600 (mm) with any thickness

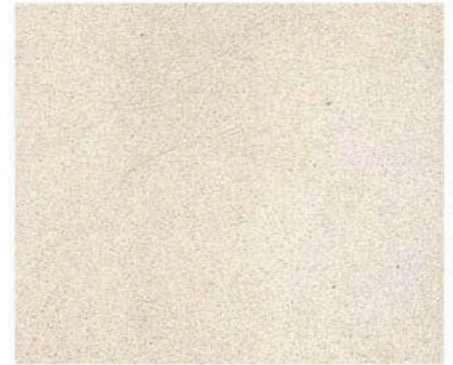

CLASSIC GOLD

Finishing : Sawn Cut, Honed, Brushed, Bush Hammered

Classic White for Wall (Courtesy Sunsea Resort Vietnam)

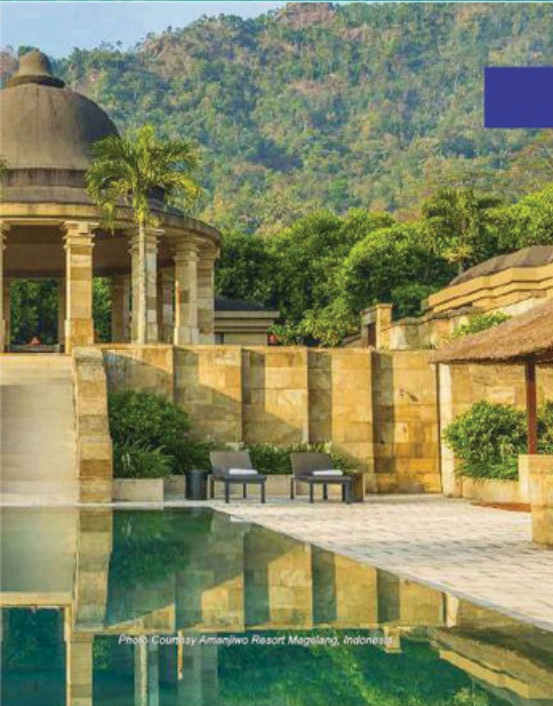

LIMESTONE

Brown Amanjiwo is a limestone with classic mixed brown, yellow and white color. This stone become famous after installed in luxury resort named Amanjiwo which located near Borobudur Temple, world largest temple.



AMANJIWO STONE (YELLOW LIMESTONE)

Available Cutting Size : 300x600, 400x400, 400x600, 600x600, 600x900 (mm)

Finishing : Sawn Cut, Honed, Etched, Bush Hammered, Brushed

Photo Courtesy Amanjiwo Resort Magelang, Indonesia



LIMESTONE

Bali Kerobokan Stone is an authentic limestone from Bali Island. Good for wall facing and more famous with the etched finish.

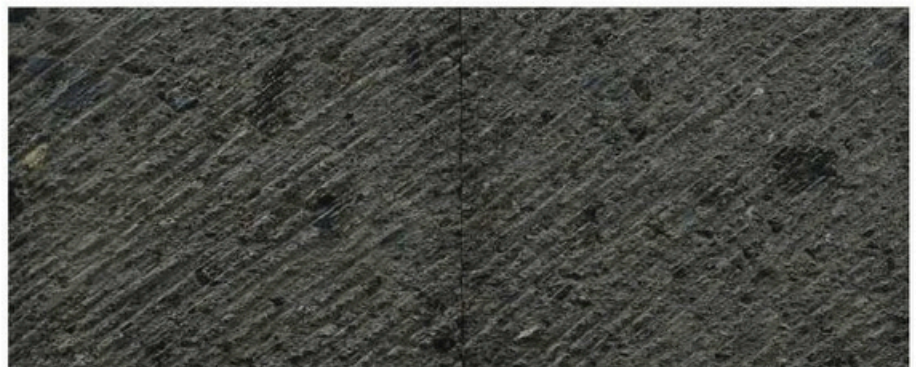

BALI KEROBOKAN STONE

Available Cutting Size : 200x300, 200x400 (mm)

Finishing : Sawn Cut, Honed, Etched

Photo Courtesy Komuna Resort Bali, Indonesia

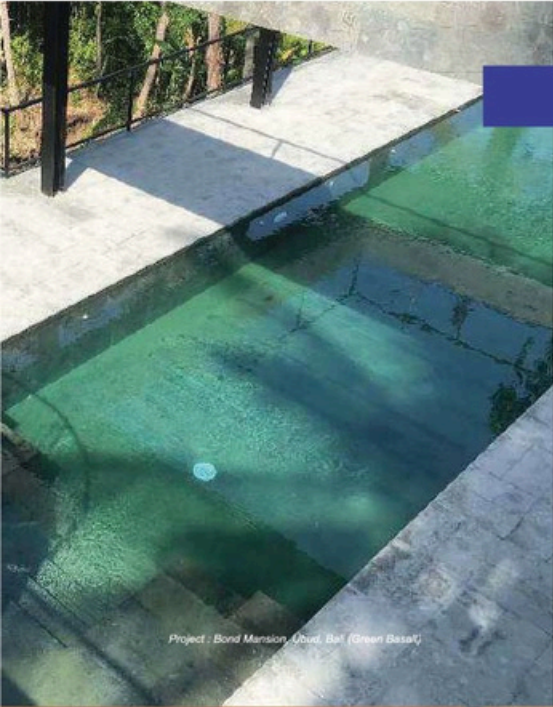

Project : Bond Mansion, Ubud, Bali (Green Basalt)

BASALT

Basalt is a very finely-grained igneous rock containing mainly plagioclase, amphibole and biotite materials. Basalt is similar to Andesite but with a higher silicon oxide content.

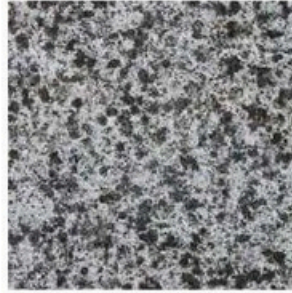

BALTIC GREY

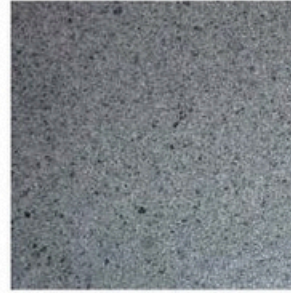

GREY BASALT

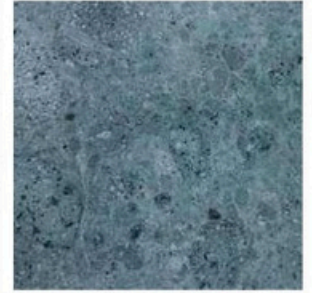

GREEN BASALT

Available Cutting Size : 300x600, 400x400, 400x600, 600x600, 600x1200 (mm)

Finishing : Sawn Cut, Flamed, Honed, Bush Hammered, Flamed Brushed, Polished



Tropical Red Basalt Polished For Wall and Floor

BASALT

Basalt is a very finely-grained igneous rock containing mainly plagioclase, amphibole and biotite materials. Basalt is similar to Andesite but with a higher silicon oxide content.



WHITE BASALT



TROPICAL RED BASALT

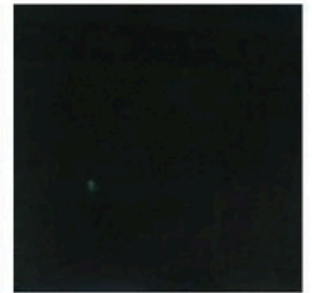

BLACK BASALT

Available Cutting Size : 300x600, 400x400, 400x600, 600x600, 600x1200 (mm)

Finishing : Sawn Cut, Flamed, Honed, Bush Hammered, Flamed Brushed, Polished



Project : Bond Mansion, Ubud, Bali

OCEAN WAVE

Ocean wave is a lava volcanic stone which has very unique green color base with grey wave. Ocean wave very nice for swimming pool tiles, wall cladding and interior floor.



OCEAN WAVE

Available Cutting Size : 100x100x10, 100x200x10, 400x600, 600x600, 600x1200 mm with any thickness, 301x301 mm mosaic in mesh

Finishing : Sawn Cut, Honed, Split Face, Polished, Bush Hammered



MARBLE

Indonesia marble stone is one of the most popular marble in the world as Indonesia has special elegant color such as creamy beige color, red color, and white color.



IMPERIAL GREY MARBLE



JAVA CREAM MARBLE



WHITE CRYSTALLINE MARBLE

Available Cutting Size : 400x400, 400x600, 600x600, 600xFree Length, 1000xFree Length mm with any thickness

Finishing : Honed, Split Face, Polished, Acid



NATURAL PEBBLES MOSAIC



BEIGE ROUND



BEIGE SLICES



BLACK ROUND



EARTHY SLICES



WHITE ROUND



GREEN SLICES



MULTI COLOR

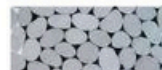

WHITE SLICES

Beach pebbles, naturally tumbled by the sea, are used to create our natural pebble mosaic. Each stone for these mosaic pebble tiles are hand selected and adhered to a mesh backing for easy installation.



PINK PEBBLES MOSAIC

Available Size : 300x300x12 mm (Inner)

Box Size : 340x340x180 mm, 1 Box = 11 pcs = 1 sqm

Finishing : Natural Doff



ONYX MOSAIC

Onyx Mosaic is made by natural onyx stone. Our onyx mosaic are easy to lay and are ideal for floors, walls, patios, conservatories, worktops and outdoors of your home.



ONYX RANDOM INTERCONNECTING

Available Cutting Size : 300x300x12 mm (Inner)

Box Size : 340x340x180 mm,

1 Box = 11 pcs = 1 sqm

Finishing : Honed - Parquet 20x20 mm and Random Interconnecting

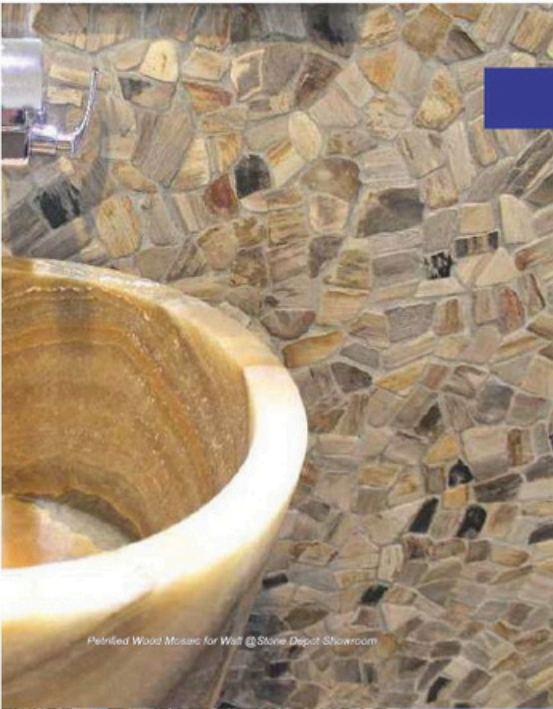

TUMBLLED MOSAIC

Our tumbled mosaic is made by natural material such as petrified wood and marble. Each piece is cut to a uniform height and size then adhered to a mesh backing for easy installation.



PETRIFIED WOOD



BROWN MARBLE



GREY MARBLE PARQUET



JAVA CREAM MARBLE



CRYSTALLINE HEXAGON



ROSSO PARQUET

Available Size : 300x300x12 mm (Inner)
Box Size : 340x340x180 mm, 1 Box = 11 pcs = 1 sqm

Finishing : Honed - Parquet and Random Interconnecting

Petrified Wood Mosaic for Wall @ Stone Depot Showroom



VOLCANIC LAVASTONE CLADDING

Black Lavastone (Pedra Hitam) also used as material for wallcladding due to this material has unique black color with small porosity on the stone surface.



CAMEL SHAPE (BIM-24)



ROCK BRICK (BLV-23)



SMALL CAMEL SHAPE (BLSC-28)



DIAMOND SHAPE (BLD-37)

Available Cutting Size : 200x400x20 mm, 150x380x25 mm (BIM-24)

Packaging : Cartoon Box, 1 Box = 6 pcs

Black Lavastone for Wall Cladding (Courtesy: The Terminal By Modern CO, Texas, USA)



BALI BLUE STONE

Blue Stone is the one of world premium class of natural stone pool tiles since its has very unique blue color.



BLUE STONE - SANDBLASTED

Available Cutting Size : 100x100x10, 100x200x10, 200x200x10, 300x300x10 mm

Finishing : Sawn Cut, Honed, Sandblasted

Sky Blue Sandbed at Villa Del Sol Koh Tao Thailand



CLASSIC PUMICE LAVASTONE

Classic Pumice Lava Stone is a lava stone with a unique hole in the stone surface.



Available Cutting Size : 300x600x15 mm
Finishing : Honed, Sawn Cut



WHITE CLASSIC LIMESTONE CLADDING

White Classic limestone wall cladding made from classic white limestone material. This stone has a pure white color which makes the beautiful white color appearance.



DIAMOND SHAPE (BLD-37)



ROUND CAMEL SHAPE (CWSC)



LINEAR WAVE SHAPE (CWLM-39)

Available Cutting Size : 200x400x20 mm
Packaging : Cartoon Box, 1 Box = 6 pcs

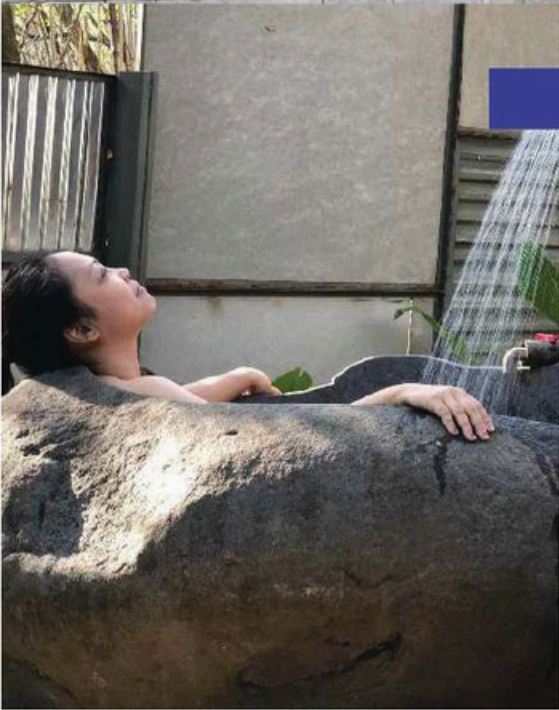

BATHTUB & SINK

Our natural stone bathtub and sink can be a good choice for your bathroom



MARBLE SINK R001
Size : 400x430x150 (mm)



MARBLE SINK R002
Size : 700x450x100 (mm)



RIVER STONE SINK R003
Size : 400x430x150 (mm)



MARBLE SINK R004
Size : 400x430x150 (mm)



Terrazzo - Green Army @SMP Santa Maria Surabaya - Indonesia

TERRAZZO FLOOR TILES

Terrazzo brings design flexibility not available in other flooring systems. An unlimited color range coupled with a plethora of aggregate options from mother of pearl, to marble, to recycled glass; these are among the many advantages offered by terrazzo.



BLACK ORANGE



GOLD CLASSIC



WHITE POP



GREEN ARMY



CLASSIC BEIGE



CORDON BLUE



GREY CLASSIC 01

Available Cutting Size :
300x600x20 mm, 600x600x20 mm
Finishing : Polished, Brushed



Terrazzo - Grey Classic @Yama Resort Tondano - Indonesia

CONCRETE TERRAZZO

Beside terrazzo tiles we also produce concrete terrazzo which offers instant application and cost efficient. Color can be customized.

CORDON BLUE

ORANGE CLASSIC

www.terramix.id

WHITE POP

WHITE POLAR

CESAR WHITE

GREY CLASSIC 02

www.terramix.id



OXA

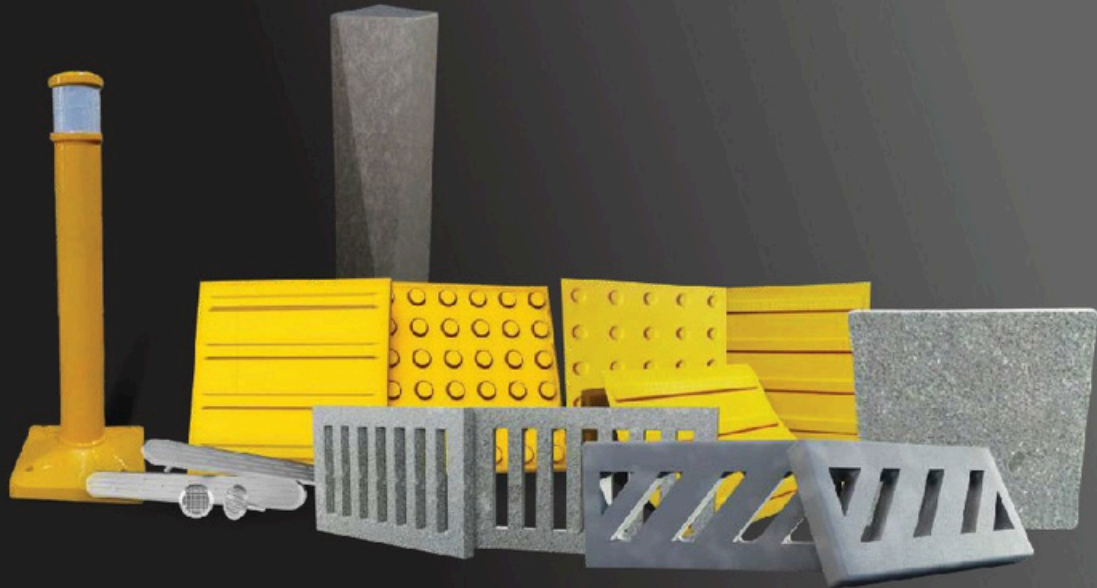

PT. Oxa Jaya Indonesia
Jl. Pluit Indah Raya Blok. BCDEFG
No. 168 Pluit, Penjaringan
Kota ADM. Jakarta Utara DKI Jakarta

☎ 0815-9353-690 / 0812-9301-4188
✉ sales@oxajayaindonesia.com
🌐 www.oxajayaindonesia.com
📷 [oxajaya.indo](https://www.instagram.com/oxajaya.indo)
📘 Oxa Jaya Indonesia